



L3HARRIS

PRODUCT GUIDE

TranSim™ Truck Driving Simulator

Product Features, Technical Specs
& Configuration Options

- 1 | Product Overview 3
- 2 | Standard Features 4
 - 2.1 Product Specifications..... 5
 - 2.2 Driver Compartment..... 6
 - Visual System 12
 - Audio System 14
 - 2.3 Standard Vehicles & Scenarios 15
 - 2.4 Virtual Driving Environments..... 41
 - 2.5 Vehicle Dynamics System 47
 - 2.6 Instructor Operator Station (IOS) 53
 - Primary Features..... 54
 - Scenario Builder™ 58
 - Replay Studio™ After-Action Review..... 60
 - Learning Management System (LMS)..... 61
 - SkillSet™ Performance Assessment..... 64
 - Training Data Security, Storage and Retention..... 67
- 3 | Product Options 69
 - 3.1 Hardware Options..... 69
 - 3DOF Motion Base 69
 - Student/Instructor Radio Communication System 69
 - Rabbit Station..... 70
 - 3.2 Software & Vehicle Options..... 71
 - Trucking Vehicles Expansion Package 71
 - Bus Vehicles Package 79
 - Snowplow Package 81
 - Virtual Environments Package..... 82
 - International Options..... 86
 - 3.3 Mobile Training Center 86
 - 3.4 Professional Services 87

1 | PRODUCT OVERVIEW

TranSim™ driving simulator provides effective hands-on, experiential training tool for commercial drivers, offering experience without risks to people or equipment. The state-of-the-art TranSim™ allows you to expose your staff to various challenging and hazard-laden scenarios in a safe, cost effective, and controlled environment. You can record operator reactions and response times, and provide after-action reviews that point out performance improvement areas for each driver. This training approach will improve your driver's critical driving skills, enhance decision making abilities, and increase the safety of your staff and the community you serve.

TranSim™ Driving Simulator provides:

- A state of the art training experience that promotes a higher transfer of learning and increased retention.
- An opportunity to standardize your curriculum to ensure consistent, quality training.
- An adjustable, progressively challenging skill development path to enhance skills, improve defensive driving techniques, and hone decision making skills.
- An extensive library of customizable scenarios designed to address learning objectives relevant to your training objectives and individual employees.
- The ability to introduce drivers to challenging situations that target skill development and increase the trainee's situational awareness, self-awareness, and critical thinking skills.
- Continual reinforcement of curriculum and key training areas by providing the ability for your students to practice and rehearse responses to dangerous situations in a safe, controlled environment.
- An after-action review (AAR) feature that allows for feedback and reinforcement, which increases the speed and effectiveness of behavior change.



Your TranSim™ will be delivered ready to train, right out of the box, including a high-resolution display system, reconfigurable instrument panel (glass dash), real-world hands-on driver controls, and an Instructor Operator Station (IOS). Additionally, we offer many options to increase training capabilities and value. L3Harris also stands ready to tailor the simulator and/or training curriculum to meet your organizational needs.

2 | STANDARD FEATURES

The modular, configurable, and ergonomic design of the TranSim™ simulator provides a replica of an actual commercial vehicle driving cab. TranSim™ accurately simulates both the vehicle's physical and functional characteristics. It also automatically adjusts its behavior to the size, weight, turning radius, eye-point, and tire and suspension characteristics for each vehicle that it simulates. Standard features include:

- **Enclosure and frame** - Constructed of durable ruggedized steel components for durability, and thick aluminum for reduced weight.
- **Displays** – Three 55” Ultra High Resolution LED LCD wide-aspect ratio monitors with a resolution of 1920 x 1080 (HD 1080), provide sharp, bright, high-contrast images with a 180° field of view.
- **Training Environments** – A number of realistic and versatile virtual environments are provided to support the effective recreation of real-world conditions. These include urban, suburban, rural, and freeway environments.
- **Sample Scenarios** – A large number of fully customizable sample scenarios are included to provide out-of-the-box training capabilities. A variety of training objectives are included such as scanning, collision avoidance, space and speed management, emergency maneuvering, shifting, backing, and reaction times.
- **Scenario Builder™** – Custom scenario creation, expansion, and modification can be easily accomplished using Scenario Builder.
- **Instructor Operator Station (IOS)** – The included IOS provides an easy, non-intimidating instructional flow to start the simulator, monitor the training progress, choose scenarios, change scenario conditions, change own cab vehicle, and interact with the driver in real time.
- **Glass Dash** – An LCD virtual dashboard that provides accurate gauges, control indicators, and warning lights. The glass dash automatically changes to mimic the dashboard of the specific own cab vehicle selected.
- **Transmission** – A real-world automatic transmission lever is included for realism, with touch screen control also included for applicable vehicles. A floor-mounted shift lever is available for manual transmission operation.
- **Mirrors** – Adjustable virtual left, right, and center rear view mirrors are embedded in the display and adjust automatically to correspond with the vehicle type and model being simulated (own cab). Convex and flat mirrors are simulated in real time to reflect realistic visibility.
- **Real World Vehicle Components**– Drivers are able to focus on training objectives while using real world vehicle components including an adjustable commercial vehicle air seat with 3-point seat belt, accelerator, brake, and clutch pedals, and a force loaded steering column with tilt, auto transmission lever on the column, turn signal lever, and hazard flashers.
- **Touch screen** – Password protectable touch panel allows the instructor and/or student full control from the driving compartment including the ability to load scenarios, modify simulator settings, and adjust vehicle features such as mirror settings.

2.1 Product Specifications

Power	
North America	
Input Volts AC	110-127 VAC~
Line frequency	60Hz
Amperage	15A
International (Configurable As Needed)	
Input Volts AC	220-240 VAC~
Line frequency	50Hz
Amperage	10A
Environment Conditions	
Temperature	50-85° F (10-30° C)
Recommended operating temperature	65-74° F (18-23° C)
Relative humidity	40-65%
Cooling	8,000 Btu/h
Dimensions	
Simulator size	110.8" (281.4 cm) W x 69" (175.3 cm) D x 79.3" (201.3 cm) H
Simulator weight	940 lb.
Disassembled clearance	32 inch wide door
Recommended clearance	Fully-assembled unit will pass through a 72-in (2 m) width double door (without center posts)
Network Communications	
Internet	One high-speed connection required

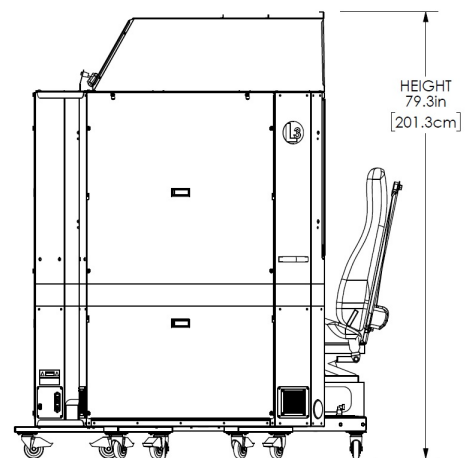
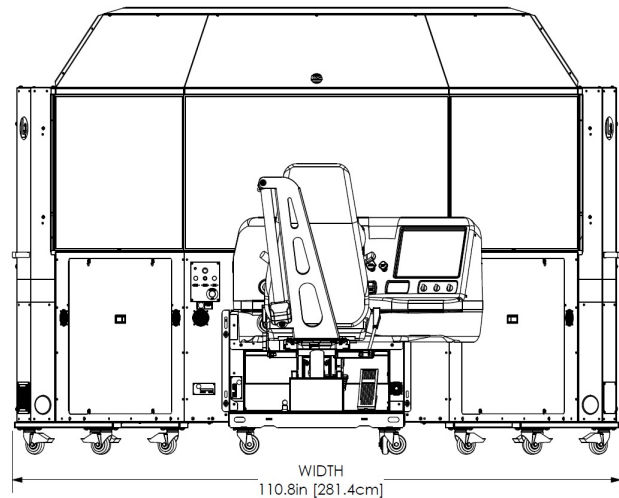
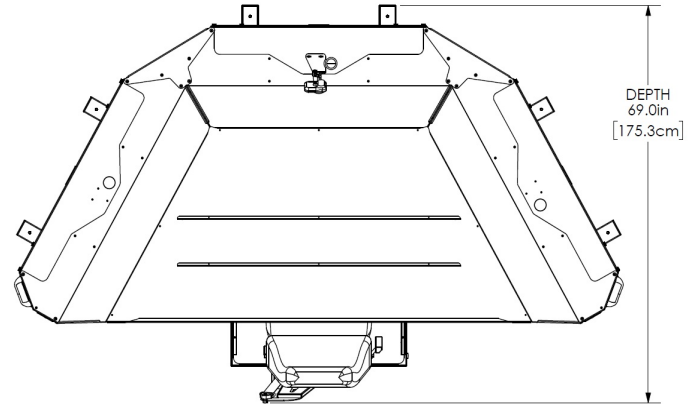

2.2 Driver Compartment

The modular, ergonomic design of the TranSim™ driver compartment has become the standard to which all other driving simulators are compared. The driver compartment is designed to provide safety, comfort, and maximize training effectiveness. TranSim™ accurately simulates the physical and functional characteristics found in existing vehicle cabs. The driver simulator compartment and dashboard replicate the ergonomics of a commercial vehicle with the instruments and equipment located in the same relative position as they are in typical commercial vehicles. Mirrors are placed in the correct locations and are adjustable, and the LCD dashboard and touch panel displays provide accurate renderings of gauges and controls. This ensures a realistic driving experience during training.



SmartNode Steering System

The simulator system features our SmartNode steering system which is the most widely used steering system in high-end driving simulators around the world. The force-feedback system has a low-inertia, direct-drive motor that connects the steering column directly to the motor shaft and updates 2,000 times per second. This allows the driver to experience real-time response from speed, friction, collision, vibration, and road surfaces without the lag imposed by chain or belt drive mechanisms.



The steering force-feedback system uses brushless motor technology and a motor controller designed specifically for driver simulator steering requirements. Along with our proprietary software, the system gives the driver extremely crisp and realistic torque cues through the steering wheel. The steering system can be programmed to emulate the performance of any vehicle, and tuned to match vehicle data and information from subject-matter experts.

The accuracy of the steering system associated with a simulated vehicle is a critically important element of the driver training experience. The steering system is comprised of the same physical components that are used in an actual truck. Features include a modern Freightliner Cascadia steering wheel fastened to an adjustable column offering tilt and ‘telescope’-style adjustments. This will allow student operators to make the adjustments necessary to establish a correct and ergonomic driving position before proceeding with the assigned training episode.

Any lag in system response to steering adjustments being applied at the wheel by the Student will be perceived as an inaccurate steering response. This is a real concern as a delayed steering response will cause the Student to make unnecessary input (adjustments) to make up for the lag in feedback being conveyed by the steering response. Lag not only has a negative impact on the training activity and but can also promote simulator discomfort.

Even a slight lag can be enough to cause steering abnormalities that make the simulated vehicle difficult to control. A steering system that lacks precision and accuracy may result in over-steer (or “see-sawing”) on the part of the student operator seeking to exert precise control over their simulated vehicle. Such struggles can make it difficult to control the simulated vehicle and may lead to difficulties during acclimation to the simulated environment.

SmartNode II was designed to eliminate lag altogether by providing an immediate response to applied driver inputs offering a high degree of precision and control that cannot be matched by other systems. The Smart Node Steering System generates an accurate turning radius and provides appropriate feedback cues to indicate the correct steering response. In addition, feedback can be generated to indicate steering axle problems, tire concerns, and a response to curb strikes, speed bumps, railroad tracks, and other obstacles that can impede the wheels and impact steering.

Automatic Transmission

An automatic transmission can be included standard with the TranSim Series 7 and is located on the column. This is the same transmission component found in many commercial vehicles, accurately replicating the feel and behavior of today’s commercial vehicles. The use of real world components provides positive training value and improved immersion for the student.



The transmission responds appropriately based on the student’s operation of the lever, allowing them to select either auto or manual mode, as well as operate the engine brake.

Manual Transmission

An industry standard floor-mounted commercial vehicle shift lever, including a range selector and splitter control, is available for manual transmission operation during training. The simulator's manual transmission is a gimbal transmission, which provides the shifting lever with an optimal range of motion and accuracy.

The TranSim™ manual transmission is designed specifically for use in training with the goals of increasing realism, reliability, versatility, and reducing maintenance. It provides fully accurate behavior and is perfect for the effective and realistic training of shifting techniques such as progressive shifting. Drivers are provided accurate shifting response, as well as realistic cues through sound and shifter behavior, such as grinding simulation, to reinforce proper techniques.



Foot Controls

The foot controls integrate real OEM components for the accelerator pedal (or throttle), brake pedal, and clutch. Components are sourced from preferred suppliers to match those in use throughout the trucking industry. The angular positions of each pedal will be sensed using long-life potentiometers to determine the degree at which the student has applied pressure as input to the brake and/or throttle (accelerator). These inputs will be indicated in real-time and conveyed to the student as an expression of vehicle performance.

Any inputs (applied by the Student) to the brake or throttle will also be conveyed (in real-time) at the IOS. Such presentation at the console will promote the observation of proper practices during the training activity. Thus, the Instructor will be able to determine if the student has lifted their right foot from the accelerator as part of their response to an adverse condition. In fact, the Instructor will be able to determine if the Student is simply covering the brake (zero angular deflection) or whether they have actually applied the brakes. This information becomes a helpful component of the feedback loop.

Glass Dash

Our Glass Dash offers a scalable and versatile instrument cluster (IC) component that provides greater flexibility for the presentation of gauges, indicators, switches, and controls. The glass dash expands the utility of the cab and reduces the potential for component-level failures.



A configurable cab will enable instructor to present variations within the equipment layout of the driver's compartment that may exist between different vehicle types, different makes and model trucks, and/or to address those changes that occur within the dash layout between model years. Model options can be added to the simulator whenever they are needed to reflect new arrivals to a fleet and to accommodate any special training considerations that may emerge in response to new equipment that might be added within the driver's area to assist the bus operator.

Switching from one instrument cluster configuration to another layout is a simple process of loading a different vehicle. Once the instructor selects the vehicle to drive, an appropriate layout of controls will be displayed and activated within the cab for use by the student throughout the exercise. The digital instrumentation is fully functional, looks and operates like the real thing, and can be modified beyond initial presets with minimal effort.

The photo-realistic, fully-functional, and accurately positioned dash instrumentation is automatically displayed on panels integrated into the dashboard. The computer-generated instrumentation is fully functional, looks, and operates like the real thing.

- Instrumentation size and shape is based on actual truck measurements and specifications.
- Glass Dash (LCD panel) provides the full instrumentation, including speedometer, tachometer fuel, temperature, and oil gauges.
- The appropriate dash is automatically loaded to match the vehicle selected for training.
- The standard Truck Vehicle library comes complete with multiple vehicle types and dash configurations.

- Our Development Services team can also create custom vehicles and the corresponding dashboards to replicate additional/new vehicles, allowing for fleet customization as needed.

The benefit of this design is that the virtual dashboard requires substantially less maintenance than fixed layouts (that rely on physical gauges, indicators, switches, and controls). The use of digital instrument clusters eliminates the potential for component-level failures that could disrupt the scheduled training activities. Glass dashes offer benefits beyond flexibility by increasing the reliability and availability of the proposed simulator.

Touchscreen

The touchscreen console, conveniently located to the driver’s right, serves as the human-machine interface (HMI) between student and simulator. The touch screen allows the instructor or the driver to easily control the basic functions of the simulator such as starting/stopping/pausing scenarios, adjusting mirrors, enabling headlights, adjusting simulator volume, or changing gears on automatic vehicles. The student is also provided with information on the transmission type corresponding with the currently loaded vehicle.

- Lesson Plan mode provides a filtered list of scenarios preprogrammed by the instructor using the built-in LMS lesson plan editor.
- MDC offers an on-screen communication display that can send and receive text instructions from the instructor at the IOS. This is ideal for simulating dispatch instructions.
- System settings allows quick access to common controls for the simulator
- Bottom tray is a virtual panel designed to load mirror controls, overhead view, map and custom lights or switches unique to a specific vehicle loaded.



OmniSim™ Modular Design

Scalable, Versatile Design - The L3Harris interactive driving simulator platform is designed with scalability and versatility in mind. We understand that customers have unique requirements and demands. Those requirements and demands may change over time. Our products take this into account by offering customers our exclusive OmniSim™ feature. OmniSim™ allows customers to train different types of drivers in different vehicle cabs using one visual display system. It is designed to minimize costs and maximize training optimization.

Multiple seat bases + single VDU = Both truck and automobile configurations with a single Simulator

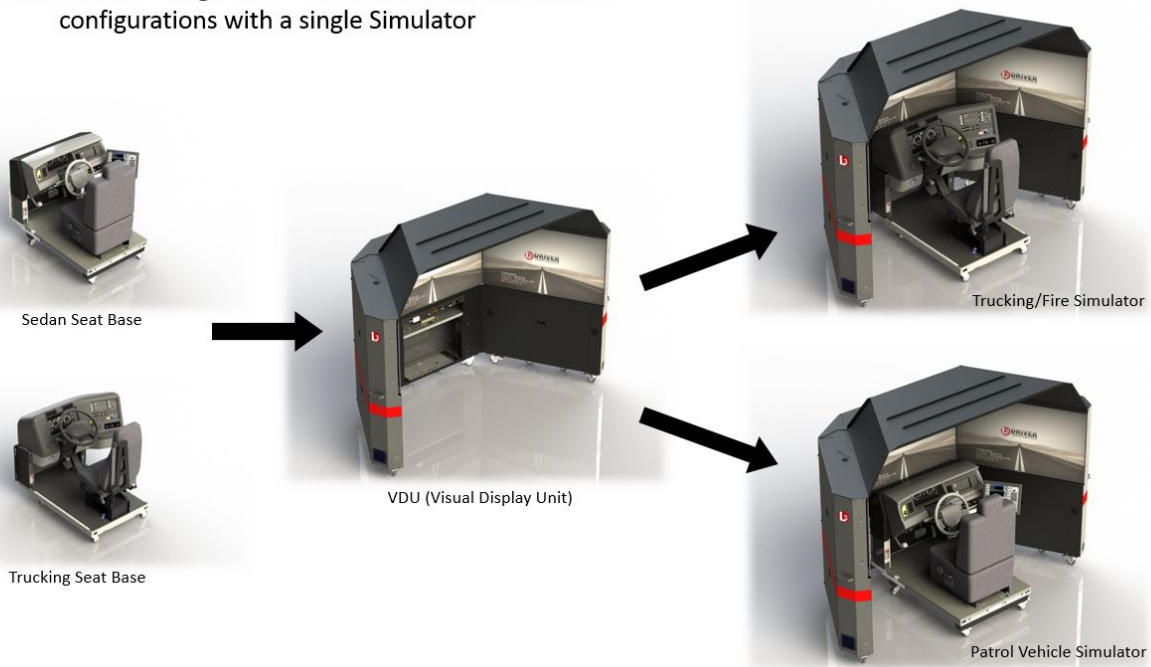

Reconfigurable System - OmniSim™ design supports reconfiguration using slide-in driver compartment cabs. This unique modular reconfiguration capability allows the customer to purchase a simulator with one type of vehicle seat base (seat, steering wheel, pedals and dash) such as a commercial trucking vehicle, and add a different vehicle's seat base such as a sedan or light vehicle in the future. In just a couple of minutes, you can unplug one seat base, and swap in another, using the same visual display system. This provides the capability of several types of simulators, with minimal investment. In the future, you could simply add a different seat base to your system and train drivers for fleet vehicles, sedans, or other light vehicle types.

Visual System

The visual system is designed to generate the highest-fidelity graphics for driving simulation applications. This is required to ensure sharp and clear visual images that improve driver comfort by reducing eyestrain and providing a truly immersive and realistic driving experience. This includes the ability to identify street signs and coordinates, recognize changing road conditions, and scan for potential hazards, all at realistic viewing distances.



Urban Environment Example with High-resolution Graphics.

Displays

The display system comes standard with three 55" 4K LED LCD wide-aspect ratio (16x9) monitors. Each monitor receives our SimView graphics generated at 1920x1080 per channel and up samples to a 4K resolution to provide ultra-sharp, dynamic color range, optimal brightness and contrast, and distortion free images. The commercial, off-the-shelf displays provide fast refresh rates of 120hz, greatly reducing the motion blur and stuttering associated with slower displays. The native resolution of the display eliminates artifacts such as image stretch or shrink. The monitors are at a consistent radius from the driver's eye-point, thereby mitigating eye fatigue issues associated with systems where the focal distance is variable. Exterior left and right mirrors and a center interior mirror, where appropriate, are simulated with images that update in real time providing the proper and realistic visibility conditions and behaviors.

The field of view (FOV) provided allows for a 180° radius from nominal seat position. The aspect ratio and diagonal size of the three displays provides an ample field of view (FOV) while minimizing artificial blind spots. This FOV allows the driver to safely train to clear an intersection for example, and the vertical FOV is as large as or larger than a typical windshield and window area.

Feature	Description
Number of Channels	3
Aspect Ratio	16 x 9
Eye Distance to Screen	38-46 inches (adjustable with seat position)
Horizontal Field of View	180° at 42-inch eye point
Vertical Field of View	33°
Scene Edge Matching	3 side-by-side monitors (2 seams)
Seam Width	Approximately ½ an inch
Rear View Mirrors	Adjustable driver's side, center, and right side insets. Side insets can include both standard and convex mirrors. Center insets may be interior or exterior rear views, depending on the vehicle.

Image Generation (IG)

Standard, commercial off-the-shelf PC’s with optimal fast-core graphics processing units (GPUs) allow us to generate the real-time imagery that makes the simulator an effective training tool, while reducing costs and maintenance drastically. The following table summarizes the features of the image generator provided standard with the TranSim.

Feature	Description
Image Generation	High-end PC-based graphics capabilities, L3Harris software
Update (Refresh) Rate	Highest available
Resolution	1920 x 1080 (HD 1080)
Texture	Photo-realistic
Time of Day	Fully adjustable, including sky models for dusk, and realistic nighttime sky
Illumination	Headlights, taillights, directional light, EVO lights, emergency vehicle lights left and right alley lights, overhead takedown lights (based on vehicle type)
Weather Effects	Multiple levels of fog, rain, snow, ice, and sun glare
Transparency	Yes
Color	32 bit

Our team has designs and develops our visual system in-house. In-house development allows us to respond quickly to our Clients’ needs and to optimize our solutions specifically for effective driving simulation and training.

This approach also allows us to be able to customize our solutions for virtually any requirement. Our use of standard, off-the-shelf components and our modular design allows us to keep current with technological advances and improve the level of performance we can provide, while keeping costs low.

Audio System

A six channel 5.1 surround-sound system, including a sub-audio tactile transducer, accurately produce sounds and audio cues to provide a realistic audio and tactile experience for the driver. These features generate vehicle sounds and tactile vibrations that are critical to the training process. They allow the student to identify and recognize important cues and responses to environmental conditions. Sounds are computer generated from recordings of actual in-cab sounds. These audio signals are played back to the driver in real time at the actual decibel levels experienced in a real vehicle. The audio and tactile sound system features include:

Audio

- Engine audio source synthesis (specific to each scenario vehicle)
- Tires and chassis digital audio replay
- Tire sounds and squeal dependent on road surface
- Wind in relation to speed and vehicle aerodynamics model
- Miscellaneous environmental sounds such as sirens and traffic
- 3D directional sounds such as passing automobiles and trucks
- Dynamic sounds that can be associated with any scenario object
- Static sounds with fixed spatial position
- Horn sounds, specific to scenario vehicle class
- Other sounds can be associated with the position of any scenario vehicle
- Traffic, sirens, and other miscellaneous environmental sounds

Tactile Feedback & Vibration

- Tactile sound transducer attached to the seat to partially simulate engine and road vibrations
- Steering wheel feel providing natural tactile stimuli amplitude correlated with tire-and-roadway interaction and engine operation, and fully synchronous and complementary with audio signals

2.3 Standard Vehicles & Scenarios



Trucking Scenarios

Provided with every TranSim™ is a library of customizable training scenarios designed to provide out-of-the-box training capabilities and enhance the skills of both experienced CDL drivers and entry-level drivers. TranSim™ comes with over 70 pre-installed scenarios that cover a wide variety of objectives in a broad range of settings including:

- City, rural, highway, and mountainous driving
- Reaction to various traffic hazards and weather/road conditions
- Demonstration of skills in speed and space management, shifting, and braking
- Ability to pass at the appropriate times, to yield right of way, and perform situational analysis to anticipate potential hazards and avoid them
- Ability to negotiate speed and avoid collisions

Automatic Transmission Vehicles

A large number of vehicle types and configurations are included with the purchase of a TranSim™. The library automatic transmission vehicles includes several different tractor / trailer / drive train combinations and dashboard configurations. Transmissions also include a variety of speeds. Each vehicle comes with a dashboard configuration that accurately reflects the cab make and model.



FREIGHTLINER CLASSIC CONFIGURATIONS

Engine	Transmission	Trailer
Detroit 515	Eaton UltraShift 10	Flat bed, empty, 48'
Detroit 515	Eaton UltraShift 10	Flat bed, half full, 48'
Detroit 515	Eaton UltraShift 10	Flat bed, full, 48'
500 HP Diesel	10 speed auto	Flat bed, empty, 48'
500 HP Diesel	10 speed auto	Flat bed, half full, 48'
500 HP Diesel	10 speed auto	Flat bed, full, 48'
500 HP DIESEL	10 speed auto	Bobtail
Mack 427	10 speed auto	Bobtail
Mack 427	10 speed auto	53' Box
445 HP Diesel	10 speed auto	48' Box
500 hp engine	10 speed auto	Tanker, Empty, 48'
500 hp engine	10 speed auto	Tanker, Half Full, 48'
500 hp engine	10 speed auto	Tanker, Full, 48'
500 hp engine	10 speed auto	Chemical Tanker, Empty
500 hp engine	10 speed auto	Chemical Tanker, Half
500 hp engine	10 speed auto	Chemical Tanker, Full
500 hp engine	10 speed auto	Propane Tanker, Empty
500 hp engine	10 speed auto	Propane Tanker, Half
500 hp engine	10 speed auto	Propane Tanker, Full
500 hp engine	10 speed auto	Lowboy Oversized Load
450 hp engine	12 speed auto	53' Box



FREIGHTLINER CASCADIA CONFIGURATIONS

Engine	Transmission	Trailer
515 HP	Eaton UltraShift 10	Flat bed, empty, 48'
515 HP	Eaton UltraShift 10	Flat bed, half full, 48'
515 HP	Eaton UltraShift 10	Flat bed, full, 48'
515 HP	Eaton UltraShift 10	Glass Trailer
450 HP	Meritor 12 speed	Box Trailer, 53'
450 HP	Meritor 12 speed	Split axle flat bed, Empty, 48'
450 HP	Meritor 12 speed	Split axle flat bed, Loaded, 48'
450 HP	Meritor 12 speed	Food tanker, Empty, 48'
450 HP	Meritor 12 speed	Food tanker, Half, 48'
450 HP	Meritor 12 speed	Food tanker, Full, 48'



FREIGHTLINER ARGOSY CONFIGURATIONS

Engine	Transmission	Axle	Trailer
450 HP	18 Spd Auto Trans	3 AXLE	Double Box
550 HP	18 Spd Auto Trans	3 AXLE	Triple Box
550 HP	18 Spd Auto Trans	3 AXLE	Flat bed, empty/half/full 48'
550 HP	18 Spd Auto Trans	3 AXLE	Tanker, Empty/Half/Full, 48'



FREIGHTLINER FL112
CONFIGURATIONS

Engine	Transmission	Axle	Trailer
350 HP	13 Speed Auto	3 AXLE	Rigid Body



ISUZU FVY 1400
CONFIGURATIONS

Engine	Transmission	Axle	Trailer
Isuzu Sitec 275 hp	6 Speed Auto	3 AXLE	Rigid Body



ISUZU FRR 550
CONFIGURATIONS

Engine	Transmission	Axle	Trailer
190 hp	8 Speed Auto	3 AXLE	Rigid Body



ISUZU NPR 250
CONFIGURATIONS

Engine	Transmission	Axle	Trailer
150 hp	6 Speed Auto	3 AXLE	Rigid Body



**STERLING LT9500
CONFIGURATIONS**

Engine	Transmission	Axle	Trailer
350 hp	18 Spd Auto	3 AXLE	12m Box



**VOLVO FH12
CONFIGURATIONS**

Engine	Transmission	Axle	Trailer
350 hp	14 Spd Auto Trans	3 AXLE	12m box



**VOLVO CONVENTIONAL
CONFIGURATIONS**

Engine	Transmission	Trailer
Volvo 425	10 speed auto	53' Box
Volvo 425	10 speed auto	28' Box
Volvo 425	10 speed auto	Bobtail
D-13	12 speed auto	48' Box
D-13	12 speed auto	53' Box
D-13	12 speed auto	48' Flat bed



VOLVO DAYCAB CONVENTIONAL CONFIGURATIONS

Engine	Transmission	Trailer
Detroit 515	Eaton UltraShift 10	53' Belly dump
Detroit 515	Eaton UltraShift 10	53' Double belly dump



SCANIA R580 CONFIGURATIONS

Engine	Transmission	Axle	Trailer
580 hp	14 Spd Auto Trans w/clutch	3 AXLE	Flatbed w/Container



INTERNATIONAL 4400 RIGID PROPANE TANKER CONFIGURATIONS

Engine	Transmission	Axle	Trailer
300 hp	6 Spd Auto Trans	2 AXLE	None



INTERNATIONAL 4400 RIGID OIL TANKER CONFIGURATIONS

Engine	Transmission	Axle	Trailer
300 hp	6 Spd Auto Trans	2 AXLE	None

Trailer Configurations for Automatic Transmission Vehicles



Box Trailer: 53', 48', 40' and 28' version included



Flat Trailer: half full



Flat Trailer: empty



Flat Trailer: full



Split Axle Flat Trailer: empty



Split Axle Flat Trailer: full



10.95 Meter Trailer

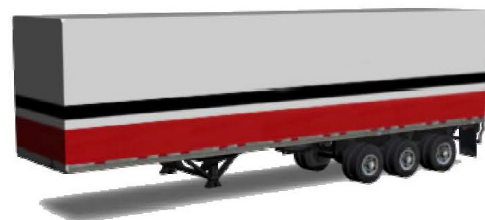

12.3 Meter Trailer



6-Meter Dog Trailer



Flatbed with Container



Tanker Trailer: full, half, and empty



Propane Trailer



Chemical Trailer



Lowboy Trailer, Oversized Load



Glass Trailer



Belly Dump Trailer (53', 40', 28')

Glass Dash Configurations for Automatic Transmission Vehicles



Freightliner Cascadia



Volvo

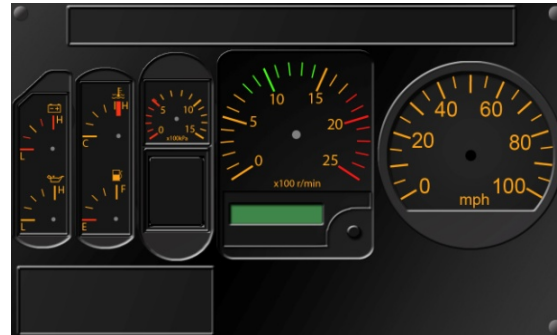

Isuzu 1400 & NPR



Freightliner Argosy

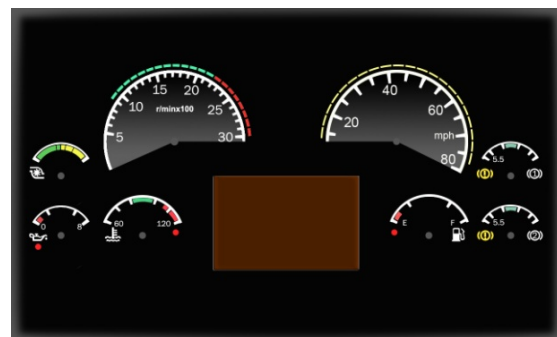

Volvo FH12



Freightliner FL112

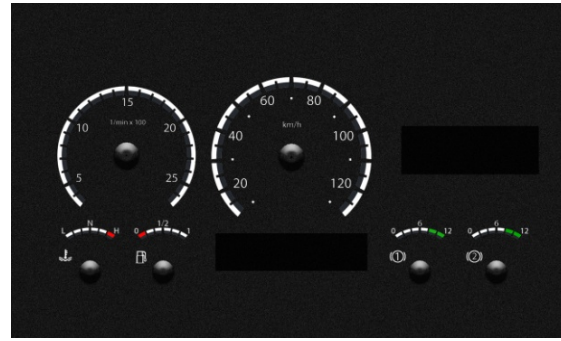

Scania R580



Sterling

Manual Transmission Vehicles

A large number of vehicle types and configurations are included with the purchase of a TranSim™. The library of manual transmission vehicles includes several different tractor / trailer / drive train combinations and dashboard configurations. Engine types include Cummins, Caterpillar, and Detroit. Transmission types include 9, 10, 13 and 18-speeds. Each vehicle comes with a dashboard configuration that accurately reflects the cab make and model.



FREIGHTLINER CLASSIC CONFIGURATIONS

Engine	Transmission	Axle	Trailer
Cummins 390	Fuller 9 manual	3.55	53' Box Trailer
Cummins 390	Fuller 9 manual	3.55	48' Box Trailer
Cummins 390	Fuller 9 manual	3.55	Bobtail
Cummins 390	Fuller 7 manual	3.55	28' Pup Trailer
Cummins 390	Fuller 7 manual	3.55	Bobtail
Cummins 380	Fuller Super 10 manual	3.7	53' Trailer
Cummins 380	Fuller Super 10 manual	3.7	Bobtail
Cummins 390	PowerShift 6 manual	3.55	28' Pup Trailer
Cummins 390	PowerShift 6 manual	3.55	Bobtail
Cummins 410	Fuller Super 10 manual	3.7	Bobtail
Cummins 410	Fuller 13 manual	3.7	Bobtail
Cummins 410	Fuller Super 10 manual	3.7	53' Trailer
Cummins 410	Fuller 13 manual	3.7	53' Trailer
Cummins 435	Fuller 10 manual	3.55	53' Trailer
Cummins 435	Fuller 10 manual	3.55	48' Trailer
Cummins 435	Fuller 10 manual	3.55	Bobtail
Cummins 435	Fuller 7 manual	3.55	28' Pup Trailer
Cummins 435	Fuller 7 manual	3.55	Bobtail
Cummins 435	PowerShift 6 manual	3.55	28' Pup Trailer
Cummins 435	PowerShift 6 manual	3.55	Bobtail



**FREIGHTLINER
CLASSIC CONFIGURATIONS**

Engine	Transmission	Axle	Trailer
Cummins 460	Fuller 13 manual	3.55	Bobtail
Cummins 460	Fuller 13 manual	3.55	48' Trailer
Caterpillar 500	Fuller Super 10 manual	3.55	48' Trailer
Caterpillar 500	Fuller Super 10 manual	3.55	Bobtail
Caterpillar 500	Fuller 13 manual	3.55	53' Trailer
Caterpillar 500	Fuller 13 manual	3.55	48' Trailer
Caterpillar 500	Fuller 13 manual	3.55	Bobtail
Caterpillar 390	Fuller 9 manual	3.55	48' Trailer
Caterpillar 390	Fuller 9 manual	3.55	Bobtail
Detroit 430	Fuller 9 manual	3.55	Bobtail
Detroit 430	Fuller 9 manual	3.55	48' Trailer
Detroit 430	Fuller 9 manual	3.55	48' Tanker Trailer, empty
Detroit 430	Fuller 9 manual	3.55	48' Tanker Trailer, half full
Detroit 430	Fuller 9 manual	3.55	48' Tanker Trailer, full
Detroit 430	Fuller 10 manual	3.55	48' Tanker Trailer, empty
Detroit 430	Fuller 10 manual	3.55	48' Tanker Trailer, half full
Detroit 430	Fuller 10 manual	3.55	48' Tanker Trailer, full
Detroit 430	Fuller 13 manual	3.55	48' Tanker Trailer, empty
Detroit 430	Fuller 13 manual	3.55	48' Tanker Trailer, half full
Detroit 430	Fuller 13 manual	3.55	48' Tanker Trailer, full
Detroit 430	Fuller 18 manual	3.55	48' Tanker Trailer, empty
Detroit 430	Fuller 18 manual	3.55	48' Tanker Trailer, half full
Detroit 430	Fuller 18 manual	3.55	48' Tanker Trailer, full
Detroit 430	Fuller 10 manual	2.64	Bobtail
Detroit 430	Fuller 10 manual	2.64	53' Trailer
Detroit 430	Fuller 10 manual	2.64	48' Trailer
Detroit 430	Fuller 10 manual	3.08	Bobtail



**FREIGHTLINER
CLASSIC CONFIGURATIONS**

Engine	Transmission	Axle	Trailer
Detroit 430	Fuller 10 manual	3.08	48' Trailer
Detroit 470	Fuller 18 manual	4.3	Bobtail
Detroit 470	Fuller 18 manual	4.3	53' Trailer
Detroit 470	Fuller 13 manual	3.55	53' Trailer
Detroit 470	Fuller 13 manual	3.55	48' Trailer
Detroit 470	Fuller 13 manual	3.55	Bobtail
Detroit 430	Fuller RTX 10 manual	3.55	53' Trailer
Detroit 430	Fuller RTX 10 manual	3.55	48' Trailer
Detroit 430	Fuller RTX 10 manual	3.55	Bobtail
390 HP Diesel	Fuller 9 manual	3.36	Flatbed trailer, empty
390 HP Diesel	Fuller 9 manual	3.36	Flatbed trailer, half or full
Mack 400	Fuller 13 manual	3.55	Bobtail
Mack 400	Fuller 13 manual	3.55	53' Trailer
Mack 400	Fuller 13 manual	3.55	48' Trailer
Mack 400	Fuller 9 manual	3.55	53' Trailer
Mack 400	Fuller 9 manual	3.55	48' Trailer
Mack 400	Fuller 9 manual	3.55	Bobtail
MaxxForce 13	Fuller 10 manual	3.42	53' Box Trailer
Detroit 430	Fuller 9 manual	3.55	Chemical Tanker, empty
Detroit 430	Fuller 9 manual	3.55	Chemical Tanker, half or full
Detroit 430	Fuller 9 manual	3.55	Propane Tanker, empty
Detroit 430	Fuller 9 manual	3.55	Propane Tanker, half or full
Detroit 430	Fuller 9 manual	3.55	Lowboy Oversized Load
Detroit 430	Fuller 13 manual	3.55	Chemical Tanker, empty
Detroit 430	Fuller 13 manual	3.55	Chemical Tanker, half or full
Detroit 430	Fuller 13 manual	3.55	Propane Tanker, empty
Detroit 430	Fuller 13 manual	3.55	Propane Tanker, half or full



**FREIGHTLINER
CLASSIC CONFIGURATIONS**

Engine	Transmission	Axle	Trailer
Detroit 430	Fuller 13 manual	3.55	Lowboy Oversized Load
DD-15 455	Fuller 10 manual	2.64	Chemical Tanker, empty
DD-15 455	Fuller 10 manual	2.64	Chemical Tanker, half or full
DD-15 455	Fuller 10 manual	2.64	Propane Tanker, empty
DD-15 455	Fuller 10 manual	2.64	Propane Tanker, half or full
DD-15 455	Fuller 10 manual	2.64	Lowboy Oversized Load
DD-15 455	Fuller 18 manual	3.55	Chemical Tanker, empty
DD-15 455	Fuller 18 manual	3.55	Chemical Tanker, half or full
DD-15 455	Fuller 18 manual	3.55	Propane Tanker, empty
DD-15 455	Fuller 18 manual	3.55	Propane Tanker, half or full
DD-15 455	Fuller 18 manual	3.55	Lowboy Oversized Load



**FREIGHTLINER CASCADIA
CONFIGURATIONS**

Engine	Transmission	Axle	Trailer
Detroit Diesel 15-455	Fuller 10 manual	2.53	53' Box Trailer
Detroit Diesel 15-455	Fuller 10 manual	2.64	53' Box Trailer
Detroit Diesel 15-455	Fuller 18 manual	3.55	53' Box Trailer



VOLVO
CONFIGURATIONS

Engine	Transmission	Axle	Trailer
Volvo 425	Fuller 13 manual	3.55	Bobtail
Volvo 425	Fuller 13 manual	3.70	53' box
Volvo 425	Fuller 13 manual	3.70	Bobtail
Volvo 425	Fuller 13 manual	3.55	53' box
Volvo 400	Fuller 10 manual	4.33	53' box
Volvo 400	Fuller 10 manual	4.33	Tanker, half full
Volvo 465	Fuller 18 manual	3.91	53' box
Volvo 500	Fuller 13 manual	3.55	53' box



VOLVO
CONFIGURATIONS

Engine	Transmission	Axle	Trailer
Volvo 500	Fuller 18 manual	4.88	28' double boxes
Volvo 500	Fuller 18 manual	4.88	40' double boxes



KENWORTH T800
CONFIGURATIONS

Engine	Transmission	Axle	Trailer
Cat 490	Fuller 10 manual	3.08	53' Trailer
Cat 490	Fuller 10 manual	3.08	48' Trailer
DT 430	Fuller 13 manual	3.55	48' Tanker Trailer, empty
DT 430	Fuller 13 manual	3.55	48' Tanker Trailer, half full
DT 430	Fuller 13 manual	3.55	48' Tanker Trailer, full



FREIGHTLINER FL112 CONFIGURATIONS

Engine	Transmission	Axle	Trailer
350 HP	13 Speed Manual	2 AXLE	



FREIGHTLINER ARGOSY CONFIGURATIONS

Engine	Transmission	Axle	Trailer
	18 Spd Manual Trans	3 AXLE	Triples
	18 Spd Manual Trans	3 AXLE	Doubles



ISUZU FVY 1400 CONFIGURATIONS

Engine	Transmission	Axle	Trailer
--------	--------------	------	---------

Isuzu Sitec 275 hp	13 speed Manual	2 AXLE
---------------------------	-----------------	--------



ISUZU FRR 550 CONFIGURATIONS

Engine	Transmission	Axle	Trailer
190 hp	6 Speed Synchro	2 AXLE	



ISUZU GIGA CONFIGURATIONS

Engine	Transmission	Axle	Trailer
425 hp	18 Speed Synchromesh	3 AXLE	12m



ISUZU NPR 250 CONFIGURATIONS

Engine	Transmission	Axle	Trailer
150 hp	6 Speed Synchro	2 AXLE	



STERLING LT9500 CONFIGURATIONS

Engine	Transmission	Axle	Trailer
350 hp	18 Spd Eaton	3 AXLE	12m

350 hp	13 Spd Eaton	3 AXLE	12m
 <p>VOLVO FH12 CONFIGURATIONS</p>			
Engine	Transmission	Axle	Trailer
445 hp	14 Spd Synchro	3 AXLE	2 Trailer
445 hp	14 Spd Synchro	3 AXLE	1 Trailer

 <p>MACK FLEETLINER CONFIGURATIONS</p>			
Engine	Transmission	Axle	Trailer
400 hp	18 Speed	3 AXLE	1 Trailer

 <p>KENWORTH K108 CONFIGURATIONS</p>			
Engine	Transmission	Axle	Trailer
450 hp	18 Speed	3-AXLE	Trailer



KENWORTH T404 RIGID CONFIGURATIONS

Engine	Transmission	Axle	Trailer
450 hp	18 Speed	3-AXLE	1 Trailer



KENWORTH T608 CONFIGURATIONS

Engine	Transmission	Axle	Trailer
450 hp	18 Speed	3-AXLE	Trailer



KENWORTH T800 SLEEPER CONFIGURATIONS

Engine	Transmission	Axle	Trailer
MX13 455	Fuller 18 Manual	3.42	2 Containers, full
MX13 455	Fuller 18 Manual	3.42	2 Containers, empty
MX13 455	Fuller 18 Manual	3.42	2 Soft Sides, full
MX13 455	Fuller 18 Manual	3.42	2 Soft Sides, empty
MX13 455	Fuller 18 Manual	3.42	2 Tankers, full
MX13 455	Fuller 18 Manual	3.42	2 Tankers, empty



**HINO 500 DUMP TRUCK
WITH EMPTY & LOADED**

Engine	Transmission	Axle	Trailer
270 HP	9 Speed Synchro Manual	2-AXLE	



**SCANIA R580
CONFIGURATIONS**

Engine	Transmission	Axle	Trailer
450 hp	18 Speed	3 AXLE	Trailer



**GENERIC DUMP TRUCK
CONFIGURATIONS**

Engine	Transmission	Axle	Trailer
460 hp	9 Speed	2 AXLE	



GENERIC TRANSIT BUS CONFIGURATIONS

Engine	Transmission	Axle	Trailer
280 hp	10 Speed	2 AXLE	



NAVISTAR INTERNATIONAL PROSTAR CONFIGURATIONS

Engine	Transmission	Axle	Trailer
MaxxForce 13 450 hp	10 Speed	3 AXLE	53' Box



NAVISTAR INTERNATIONAL PROSTAR, 2015 CONFIGURATIONS

Engine	Transmission	Axle	Trailer
MX13 455	Fuller 18 Manual	3.42	2 Containers, full
MX13 455	Fuller 18 Manual	3.42	2 Containers, empty
MX13 455	Fuller 18 Manual	3.42	2 Soft Sides, full
MX13 455	Fuller 18 Manual	3.42	2 Soft Sides, empty
MX13 455	Fuller 18 Manual	3.42	2 Tankers, full
MX13 455	Fuller 18 Manual	3.42	2 Tankers, empty

Trailer Configurations for Manual Transmission Vehicles



Box Trailer: 53', 48', 40' and 28' version included



Flat Trailer: half full



Flat Trailer: empty



Flat Trailer: full



10.95 Meter Trailer

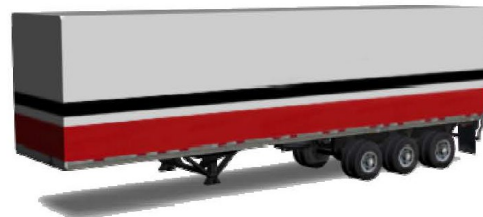

12.3 Meter Trailer



6-Meter Dog Trailer



Flatbed with Container



Tanker Trailer: full, half, and empty



Propane Trailer

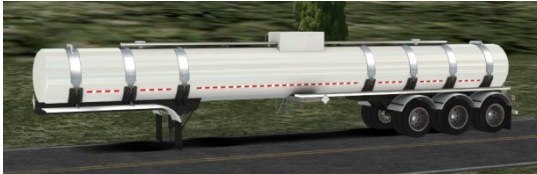

Chemical Trailer



Lowboy, Oversized Load



40' Soft Sided Box Trailer

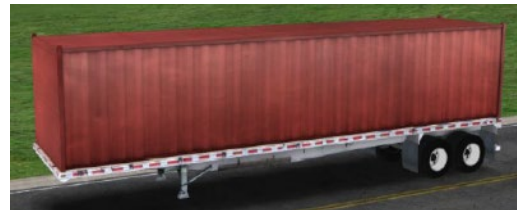

40' Shipping Container on Flat Bed



Belly Dump Trailer (53', 40', 28')

Glass Dash Configurations for Manual Transmission Vehicles



Freightliner Cascadia



Volvo



Navistar International ProStar



Freightliner Argosy



Isuzu 1400 & NPR

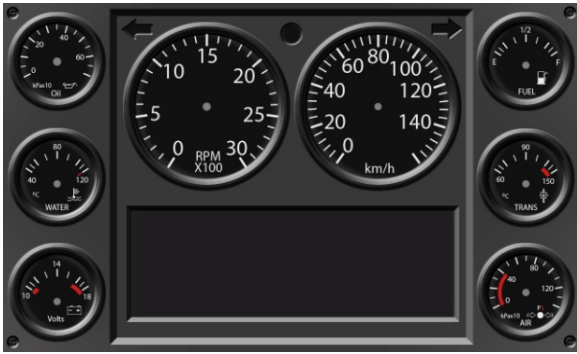

Freightliner FL112

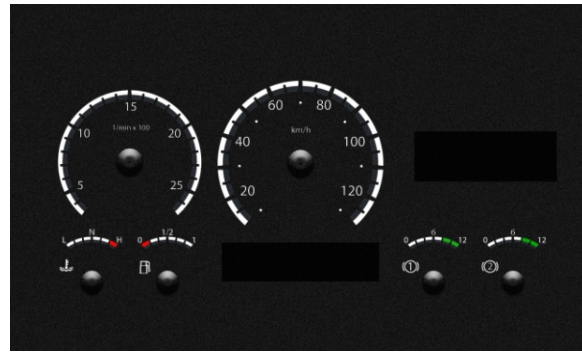

Scania R580



Sterling

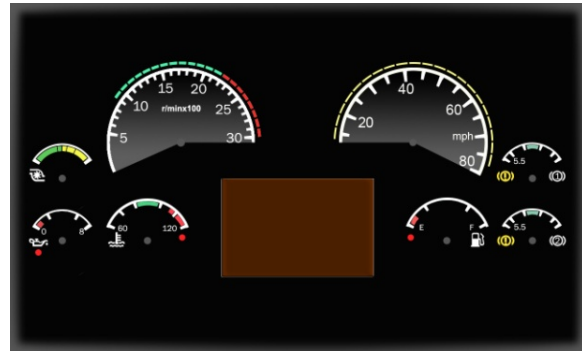

Volvo FH12



Isuzu Giga



Kenworth T608

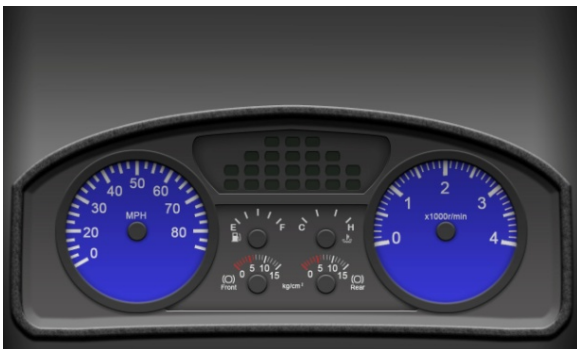

Hino 500

2.4 Virtual Driving Environments

A number of realistic and versatile virtual environments are provided to support the effective recreation of real-world conditions. The virtual environments that come standard with TranSim™ include rural, freeway, city, suburban, business, industrial, and residential areas, all including objects and features representative of those areas. The road networks have paved and unpaved roads that range from simple trails to four-lane freeways. Divided freeways include mountain areas, runaway ramps, on-off ramps, and rest areas.

Roads and highways in the virtual world are designed in accordance with standard highway specifications for grade, width, curvature, and overpass height. Traffic control signals and highway markings are consistent with standard street and highway markings. Road types are appropriate to each environment, and are consistent with real-world conditions.

Roads include expressways, multi-lane highways (interstate), high-speed entrance/exit ramps, cloverleaf and trumpet intersections, over/under passes, elevated/below grade highways, foot bridges over the roadway, ascending/ descending gradients with switchbacks, mixed surface types (concrete/gravel/asphalt), speed-bumps and dips. Major country road surfaces are uniform and smooth with little or no shoulder. Some country roads are made up of either gravel or dirt surfaces with accompanying changes in traction.



Suburban / Downtown Zone

Typical suburban downtown cultural features are provided in this environment, including: office buildings, hospitals, stores, banks, restaurants, fire stations, loading docks, bridges, multi-lane roads, street junctions, functional stoplights, road signs, traffic control signs, typical vegetation, multi-lane streets, construction zones, dead-end roads, and narrow streets.



Suburban / Residential Zone

Typical features provided are hospitals, single-family homes, schools, apartment complexes, fire stations (drive through capable), strip-malls, restaurants (fast food w/drive through), banks, functional stoplights, road signs, traffic control signs, typical vegetation, driveways and sidewalks. Multiple roadways (two lane, four lane), intersection types, buildings etc., provide an excellent place to practice a wide array of driving maneuvers.

The Suburban/Residential/Downtown area also includes these features:

- walk / don't walk indicators with 'stale green'
- speed signs
- open areas
- fire station
- warehouse for backing
- parking meters
- school with school zones
- canyon area
- narrow single-lane bridge.



Rural/Country

This environment incorporates numerous hills and winding two-lane roads. Limited visibility and sudden curves enhance training in speed and vehicle control. There are straight sections with limited foliage as well as winding sections that contain blind curves. Features include: branching Y-type roads, single-track bridges, rail-road tracks/crossings, open multi-lane interstate highways, blind intersections, and small, roadside villages.



Urban City Area

A moderately-urban area containing dead-end alleyways, graffiti covered buildings, parking garages, sharp turns, a bridge, tunnel, and high rise buildings. This driving environment allows continuous driving across multiple types of city environments.



Freeway

The freeway driving area includes more than 23 miles of two- and three-lane roads with overpasses, on-ramps, off-ramps, canyons, truck runaway lanes, six-percent grades, a rest area, and all of the appropriate signage.



Mountain Pass

This driving environment has 14 miles of winding mountain roads and several miles of forest trails. There are steep drop-offs, bridges, switchback curves and tunnels. The mountain environment is useful for training on windy, narrow, snowy, and slippery roads. It is an environment representing Wolf Creek Pass in Colorado.



Skid Pad

Skid Pad is a simple, flat asphalt environment, with a large puddle in the center of it. This environment includes markings and cones, and allows drivers to practice simple emergency maneuvers and avoidance.



Trucking Course:

The Trucking “Rodeo Course” is a comprehensive skills test environment based on the ATA Standards. Challenges include: 90 degree Left Turn, Front Line Stop, Serpentine, Lateral Parking, 90 degree Right Turn, Diminishing Clearance, Scale Stop, Offset Alley, Fuel Dump, Pull Thru, Back Thru, Pull Thru Alley, Rear Line Stop, Parallel park, and Alley Dock, or Bull Pen Dock (Instructors Choice).

Virtual Environment Features

The following features are available in the standard environments:

- Alleyways
- Hidden oncoming traffic
- Roads with gravel surfaces
- Animated smoke and fire
- Hilly roads
- One-way streets
- Appropriate signage
- Large parking lots
- Roads w/uneven (partially paved) surfaces
- Blind intersections
- Roundabouts
- Neighborhoods
- Steep grades and inclines
- Operational traffic lights
- Crosswalks
- Street signs
- Police station
- Farms
- Shopping areas
- Railroad tracks
- Gas stations
- Residential properties
- Road workers with active stop/slow signs
- Flashing arrow boards for construction zones
- Wide variety of fixed/moving objects
- Bike Lanes
- People / Pedestrians in various activities
- Caution signs
- Multiple lane roads
- School zone
- Civic centers
- Narrow roads
- Small roadside villages
- Commercial properties
- Narrow, single lane bridges
- Speed limit signs
- Construction vehicles
- Speed-bumps and dips
- Construction zone
- Parks
- Cul-de-sacs
- Railroad crossings
- Stop signs
- Winding lanes
- Wooded area
- Roads with overhead pedestrian crosswalks
- Construction zone barriers, cones, etc.
- Branching "Y" roads with appropriate signage
- Warehouse with loading dock
- Large connected parking lots for backing.

Commercial Vehicle Environment Features

The following features have been developed based upon the needs of those operating in the commercial vehicle industry:

- Accurate representation of side rearview mirrors
- Parabolics for curved mirrors
- Correct size and position relative to driver
- Accurate road markings
- Animated animals with walking motion
- Construction vehicles
- Construction worker with active stop/slow sign
- Dark night scenes with limited visibility
- Flashing arrow board for construction zones
- Large moving vehicles in scenarios with trailers
- Narrow single lane bridge
- Overhead traffic lights
- Roads with gravel surfaces
- Roads with hills and valleys
- Roads with overhead pedestrian crosswalk
- High detailed road surfaces
- Steep inclines and declines
- Roads with uneven (partially paved) driving surfaces
- Potholes of various sizes that can be randomly placed in the road
- Multiple billboards that can be modified with customer specific images
- Vehicles with doors that open (not all vehicles have this feature)
- Full control of traffic light timing (control timing for red, yellow and green light states)
- Walking pedestrian models of men, women, teens, and children
- Large set of scripting commands to control scenario vehicles, pedestrians, animals, environment, audio, etc.
- Railroad crossing with flashing cross-bucks, animated crossing arm and active train

2.5 Vehicle Dynamics System

The L3Harris Multi-Chassis Dynamics (MDYN) system used in the TranSim™ is based on sophisticated automotive engineering concepts and are driven by both measured physical characteristics and manufacturer specifications. The resulting vehicle behavior model has been validated against published proving ground results and vetted with industry experts. Our vehicle dynamics models are comprehensive enough to represent real vehicle behavior. Each tire, wheel, suspension point, steering system, engine, transmission, drive train, and chassis is modeled.

The advanced physics model includes a 21 data point model representing tires, suspension, vehicle chassis, steering and power train. This level of sophistication matches that in engineering applications and enables our use of vehicle manufacturer and other OEM data.

Vehicle Dynamics Modes Simulated

TranSim™ operates across a wide range of performance modes consisting of several vehicle and environmental factors according to vehicle manufacturers' specifications.

- **Normal Operation:** The default vehicle dynamics setting is normal operation.
- **Vehicle Motion:** Vehicle suspension and motion are accurately simulated using vehicle manufacturer's data. Visual cues are provided to the student by the displayed vehicle moving and responding in concert with the vehicle's steering, acceleration and braking factors.
- **Speed:** Acceleration and speed are accurately simulated based on the precise vehicle models incorporating actual vehicle engine and other drive train specifications.
- **Environment Surface/Conditions:** Environment surface conditions change appropriately with rain, snow, and ice.
- **Transmission Selection:** Transmissions, both manual and automatic, are modeled in each vehicle's dynamics model according to the manufacturer specifications.

TranSim™ provides vehicle dynamics models that are modular and adjustable representations of actual vehicles' subsystems. The tire patch model provides interaction with the road surface to simulate actual skids, tire envelopment over objects, and road hazards. The accurate tire-and-road model interacts with dynamic forces on the simulated vehicle to allow a full spectrum of tire reactions, so the driver feels a variety of forces and sensations as the wheels interact with surface variations and objects.

Vehicle Subsystems

Simulated vehicle subsystems are an integral part of the vehicle model. The modeled subsystems include:

- power/drive train (engine, transmission, axles)
- braking system
- suspension system
- tire system
- chassis system
- control inputs (throttle, brake, clutch, steering, gear selection)
- disturbance inputs (wind, terrain, collisions)
- instrument panel outputs (vehicle speed, engine speed, warning lights, etc.)
- on-screen displays of vehicle speed and compass
- animated windshield wipers controlled by in-cab wiper control switch

All subsystems use sound automotive engineering principles and simulate real vehicle counterparts.

Anti-Lock Braking Systems (ABS)

We've designed nearly all of our vehicle models to operate in the simulated environment in a manner consistent with the use of an ABS system. ABS function also provides simulated braking feedback forces on the pedal, providing the student driver with realistic tactile feedback in keeping with real vehicle behavior. Braking efficiency is also realistic and in accordance with road conditions. The ABS function can be configured, before or during the simulation, from the Instructor Operator Station or via scripted scenario input. The instructor may select rear-wheel ABS, all-wheel ABS (for vehicles so equipped), no ABS, or choose to return the vehicle to its default setting.

Collision Detection

TranSim™ detects all collisions between the student vehicle and objects in the scene. Collisions are detected and responded to immediately upon contact. Relevant information about the collision is reported to the host computer. Collisions of varying speed or size are treated with appropriately varying severity, with corresponding differences in the visual and dynamic feedback. The instructor has control over whether or not collisions halt the scenario or damage the student vehicle.

Advanced Driver Assist Systems (ADAS) Features

The TranSim™ comes standard with some of the latest advanced driver assist systems and vehicle safety features including simulated warnings and controls, some common to most vehicles, and some specific to individual vehicle models or types. These may include:

➤ **Cruise Control / Adaptive Cruise Control**

The physical Cruise Control buttons on the left side of the steering wheel are active, allowing the driver to enable/disable, set, resume, accelerate and decelerate using the real buttons instead of the previous touch screen based buttons.

Adaptive Cruise Control (ACC) is enabled by default, and can be enabled/disabled and manipulated using virtual controls provided on the touch screen. This feature provides feedback to the driver when they are getting too close behind another vehicle, and will take control of the accelerator and/or brake as needed to reduce speed and prevent a collision. Standard Cruise Control must also be active for the Adaptive feature to work.

➤ **Descent Control**

On applicable vehicles, such as semi-tractor trailer rigs, the Descent Control system uses a combination of Cruise Control, engine braking, and the service brakes, as needed, to control the vehicle's road speed during a descent to prevent a runaway situation.

➤ **Collision / Following Distance Warning System**

On applicable vehicles, proximity to vehicles in front is monitored, with warning and emergency levels of dashboard indication, blinking, and audible alarm depending on how close the driver gets and whether they are getting closer or farther away from said vehicle.

➤ **Gear Lockout Requiring Brake Pedal Application**

On applicable automatic vehicles, the service brake must be applied in order to shift the transmission out of neutral and into any forward or reverse gear.

➤ **Hill Start Aid**

This feature holds the service brake ON for three seconds after the driver removes his foot from the pedal when on a grade, allowing them the time to apply the accelerator before the vehicle rolls unintentionally. If the driver doesn't apply either the brake or the accelerator within that three seconds, a beep sounds, notifying the driver that the brake is being automatically released.

➤ **Creep Mode**

This feature allows applicable automatic vehicles to be placed in a "Crawl Speed" mode by quickly depressing and releasing the accelerator pedal. While in Creep Mode, the speed can be increased or

decreased between 1 and 3 miles per hour by using the Manual Mode gear shift paddle operation on the shifter stalk.

➤ **Automatic Manual Transmission (AMT) Mode**

On applicable automatic vehicles, the transmission can be placed in Auto or Manual Mode using the appropriate button the shifter stalk. During Manual Mode, the gear can be changed up or down using the Manual Mode gear shift paddle operation on the shifter stalk.

➤ **Starting Gear Selection**

On applicable automatic vehicles, the shifter stalk can be used to select the desired gear that the vehicle should start out in each time it is moved from a stop.

➤ **Engine Overspeed Warning**

On applicable vehicles and dashboards, the engine speed (RPM) is monitored, and when it exceeds prescribed levels, a yellow or red warning indicator is displayed on the dashboard, and in the worst case, engine damage occurs.

➤ **DEF Level Indication and Low Level Behavior**

On applicable vehicles, the DEF level is displayed on the dashboard. If it falls below prescribed levels, a low level warning light appears, the DEF indicator blinks, and engine output and top vehicle speed are both derated.

➤ **Dashboard and Warning Indications**

In addition to the standard instrumentation and indicators found on most dashboards, select L3Harris dashboards may have the following, depending on vehicle model and configuration.

- Most dashboards include indicators for Cruise Control Enabled, Cruise Control Set, and Adaptive Cruise Enabled
- Current gear number.
- Indication of whether the vehicle transmission is in Automatic or Manual mode.
- Up and down suggested shift arrow prompt for staying in an appropriate gear for the current road speed.
- DEF Status
- Collision warning
- Engine Overspeed indicator

Road Modeling

Roads are high-resolution, 3D surface models with curbs, gutters, soft edges, variations in surface texture and content, and assorted hazards. Some have super elevation for banking around curves. Some road surfaces are designed to the U.S. Standards for Highways or The American Association of State Highway Traffic Office. Available road surfaces include:

- Asphalt
 - Cement
 - Gravel
- Sand
 - Dirt
 - Mud
- Ice
 - Snow
 - Pot Holes

In addition to 3D road-surface models, we sample the critical interface between tire and road at a rate of around 960 Hz. This is essential to capture accurate vehicle position, road feel, and vehicle control. At this rate, the distance we measure between tire-and-road samples is 1.7 cm at 60 km/h. For comparison, if a simulator sampled its tire-and-road interface at 60 Hz, the distance between tire-and-road samples would be 27.7 cm. Sampling at lower frequency does not provide high-fidelity modeling of vehicle control.

Our proprietary 3D road surface model, which is far superior to our competitors’ polygon-based road surfaces, interacts with the vehicle’s dynamics and tire models. As no road in the real world is completely flat, our unique technology can accurately simulate uneven and crowned road surfaces for a more realistic training experience.

Tire Modeling

Accurate capture of vehicle behavior is dependent on a high-fidelity tire model. Our model captures the tire behavior from stopped to high speeds and from nominal driving to complete loss of traction on all kinds of road surfaces. The model captures all of the standard Society of Automotive Engineers performance measures for ride and handling simulations, including:

- normal forces and vertical displacement
- lateral slip, slip angle, and normal force
- longitudinal force, rolling slip, and normal force
- composite vector limits on total reaction force and normal force.

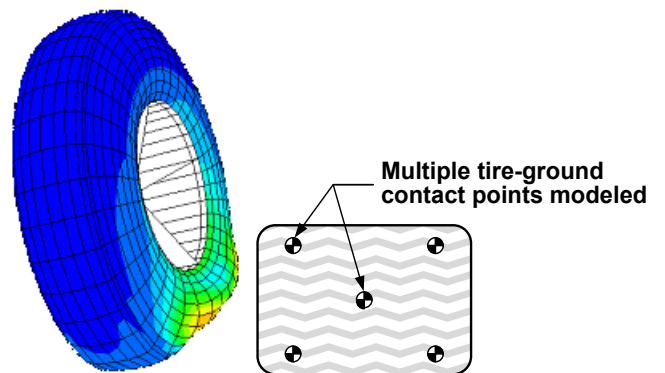

Most simulation models use only a single point to represent the patch of the tire that contacts the road. Our superior tire model uses up to five sample points to fully capture the interaction of tires with the road. Automobile and tire manufacturers supplied the high fidelity data on tire forces for our model, which lets drivers feel the effects of tire impacts through our direct-drive SmartNode II steering system.

Basic Mode

Provided standard with the TranSim™ is the ability to operate the simulator in Basic Mode. This provides entry level driver training shifting skills, progressive shifting techniques, and basic fuel management training.

Basic Mode Vehicle Dynamics

The basic mode offers an extensive array of simulated engines, transmissions, axle ratios, and tire sizes. Users can choose from more than:

- 240 engine types
- 140 transmissions
- 33 axle ratios
- 300 tire sizes

Engine types include: Cummins, Caterpillar, Detroit Diesel, Volvo, Ford, and Mack

Non-synchronized transmissions include 9 speeds, 10 speeds, 13 speeds and 18 speeds. An RPM / Road Speed table is also provided for each vehicle combination to demonstrate shifting and fuel management techniques.

Basic Mode Vehicle Characteristics and Driving Conditions

The load carried by the vehicle can be varied from 35,000 to 200,000 pounds GVW. In addition, the grade of the road driven can be adjusted for uphill and downhill environments.

Basic Mode Driver Information Screen

The information presented on the screen in front of the driver is pictured above. This screen provides the driver with useful learning cues including:

- RPM shift point curve
- Fuel mileage
- Shifting pattern for selected transmission
- Vehicle load and road grade
- Percent clutch, brake, and accelerator pedal application
- Clutch brake applied.



2.6 Instructor Operator Station (IOS)

The purchase of a TranSim™ simulator includes a user friendly Instructor Operator Station (IOS). The instructor's computer skill level need only be sufficient to operate a word processor or similar type of program. A Windows™ format Graphical User Interface (GUI) on the instructor's computer screen provides an easy, non-intimidating instructional flow to start the simulator, choose scenarios, change scenario conditions, change vehicles, and interact with the driver in real time during training.



The instructor station includes multiple display areas and icon control buttons. A single screen provides all the functions required for one instructor to control all the training and simulator control functions for up to four simulators. The operator uses an ordinary mouse and keyboard to select and activate functions. The operator can control and manipulate individual vehicles in the driving scenario while the scenario is running. From the instructor station, for example, a car can be made to drive aggressively or stop quickly in front of the driver when the instructor commands it to happen.

The IOS allows the operator to select the vehicle type and dynamics to be driven by the student, (owncab). For example, a tractor with a 53-foot trailer can be selected then driven by one student while another student drives a tractor with a 48-foot trailer. Each simulated vehicle's feel and performance will approximate that vehicle's size, weight, turning radius, tire and suspension characteristics, etc.

Primary Features

- An easy-to-use, menu-driven GUI
- Graphical Toolbars
- Large simulation environment viewport
- 3D Displays updated in real time showing status and activity

Real-Time Feedback

While the student is driving in the simulator, the Replay Control software records and reports violations, warnings, and other events as they occur. A recording file can be saved, and replay can be started at a point just prior to any violation. A scroll bar allows the instructor to move quickly to any point in the recording. From the IOS, the instructor has complete control and visibility of the training experience.

The student's drive can be recorded and played back. This is a great training tool that can help the driver see his proximity to other vehicles or objects during the replay. When a trainee hits an object, the scenario can continue or stop, depending on how the instructor sets up the scenario at the IOS.

Vehicle Control

The instructor can control scenario vehicles within a scenario from the IOS. The behaviors of the scenario vehicles that can be controlled include:

- Speed
- Forward/reverse direction
- Obedience to rules of road (stop, yield, etc.)
- Driver drunkenness
- Aggressiveness

Scenario Control

From the IOS, the instructor can control traffic in the scenario in a number of ways. Traffic can be pre-set, so that vehicles will behave autonomously according to the preset rules of the road or the parameters chosen by the scenario creator. In addition, the instructor can, during the scenario, trigger events and/or take control of any vehicle. Events can be triggered manually, or they can be set to be triggered by dependencies during the scenario by the scenario creator. For example, after a certain amount of time has elapsed, once a certain speed has been reached, once the driver enters a certain zone, etc.

The following are examples of elements that the IOS brings under the control of the instructor:

- The simulator can create day, dusk or dawn, and night conditions. Each setting enables a new sky model to provide the appropriate visual effect.
- The instructor can control weather effects and road conditions in real time or can script them into scenarios using the Scenario Builder scenario creation tool. The instructor can modify environmental conditions in real time. Environmental conditions include rain, snow, ice, fog, and wind. Each of them is configurable from very light to very heavy.
- The instructor can control the vehicles in a scenario (see above).
- The instructor can monitor the following functions for each simulator running (up to 4 from a single IOS) using the SimTile Panel.

Multi-Sim Networking

TranSim™ is designed to function either as a stand-alone unit, or as part of a network of simulators. Up to four simulators can be controlled by a single IOS. This allows multiple students to interact with each other in the same scenario, providing opportunities for group training.



SimTile Panel

The SimTile panel collects and provides information and indicators that let the instructor view the driver input and vehicle status for a given simulator in real time.

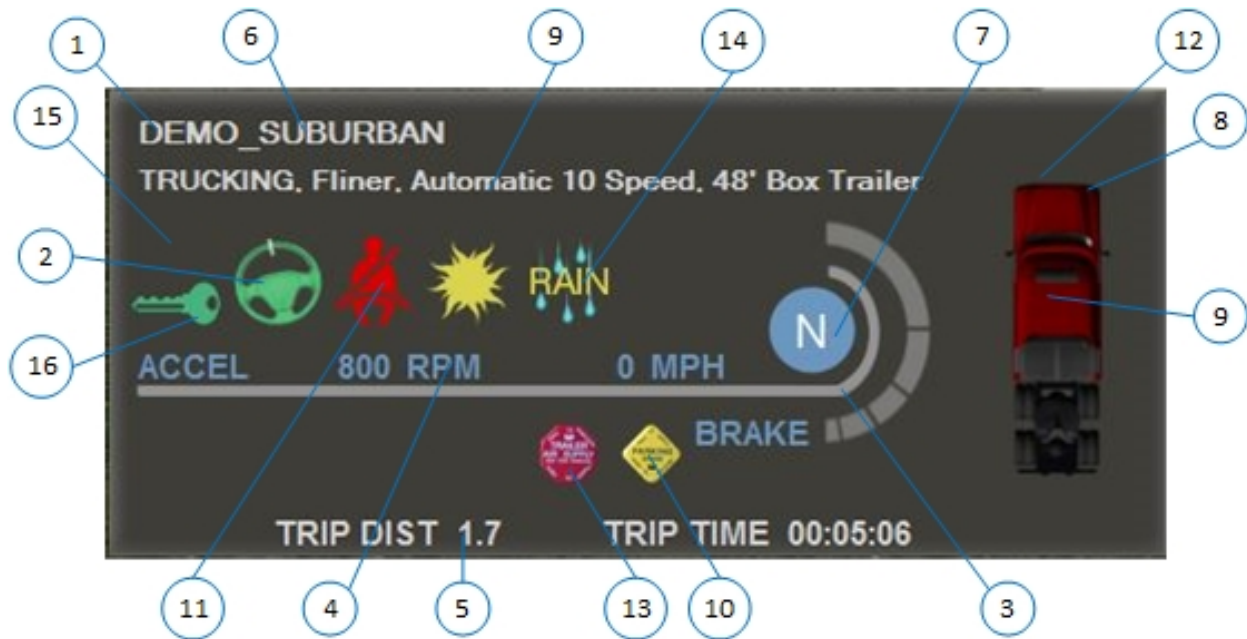

- | | |
|-----------------------------------|-----------------------|
| 1. Scenario and vehicle names | 9. Owncab model |
| 2. Steering wheel position | 10. Parking brake |
| 3. Brake, accelerator, and clutch | 11. Seat belt |
| 4. Speedometer and tachometer | 12. Headlights |
| 5. Time and trip distance | 13. Trailer air brake |
| 6. Host computer status | 14. Scenario status |
| 7. Transmission status | 15. Horn |
| 8. Turn signals | 16. Ignition |

Vehicle Malfunctions

These failures and conditions can be pre-programmed in a driving scenario, or selected by the instructor in real time during a training exercise. Driver performance in response to malfunctions and emergency conditions can be recorded, some automatically and others manually under instructor control. Not all malfunctions are available on all systems since failures are mapped to the vehicle type.

- **Blowout Tires:** blow out left tire, blow out right tire, restore left tire, restore right tire
- **Failing Brakes:** fail brakes, restore
- **Smoking Brakes:** left, right, restore
- **Engine Temp:** overheat, restore
- **Engine Failure:** fail, restore
- **Oil Pressure:** fail, restore
- **Failure of Headlights:** left, right, both, restore
- **Low Fuel:** low, restore
- **Engine Faulty:** faulty, restore
- **Fail Headlights:** left, right, both, restore
- **Locked Brakes:** front left, front right, rear left, rear right, trailer left, trailer right, restore
- **Wait to Start Lamp:** on, off
- **Maintenance Lamp:** on, off
- **General Warning lamp:** on, off
- **Stop Alert Lamp:** on, off
- **High Exhaust Temp Lamp:** on, off
- **DPF Status Lamp:** on, off
- **Malfunction Lamp:** on, off
- **Transmission Temp:** high, restore
- **DEF Level:** empty, low, 25%, 50%, 75% FULL

Weather Effects and Variable Road Conditions

The simulator provides a full range of weather controls of varying intensity. Weather effects/road conditions can be controlled in real-time by the Instructor or scripted into scenarios. Environmental conditions can be modified in real-time and include the following options:

- **Rain:** Selections are Very Light Rain, Light Rain, Medium Rain, and Heavy Rain.
- **Snow:** Selections are Very Light Snow, Light Snow, Medium Snow, and Heavy Snow.
- **Ice:** Selections are No Ice or Ice Levels 1 through 5.
- **Fog:** Selections are Very Light Fog, Light Fog, Medium Fog, and Heavy Fog.
- **Wind:** The operator uses the wind-active Enable/Disable buttons to enable or disable wind at any time. Wind in the simulation is comprised of three parts: Wind speed (MPH) and Heading (the direction in degrees), and Gusts (speed/frequency, number of gusts per second).
- **Sun Glare:** A sun glare effect appears on the center channel (screen) when facing east in the morning, and west in the evening.
- **Time of Day:** The simulator provides a full range of day, dusk, and night capabilities.

Scenario Builder™

Scenario Builder is a software package that provides a simple, user-friendly interface that will facilitate the creation of scripted or pre-defined training scenarios. Scenario Builder was designed to enable training teams to develop accurate roadway conditions needed to fulfill specific training objectives.



Scenario Builder offers a windows-based interface with menus that enable users to direct the placement and behavior of each traffic element that will be presented as part of the pre-defined training exercise. In addition to vehicles, Scenario Builder supports dynamic pedestrians and the placement of objects such as road barricades, traffic cones, traffic signs, and other common objects that may appear near, alongside, and also on roadways. A library of static objects is available that can be used to further enrich the virtual driving environment with the desired hazards, obstructions, and conditions needed to promote the immediate learning objective.

Scenario Builder™ will enable instructor to:

- Build customized scenarios in less than thirty minutes.
- Use preloaded or existing scenarios as a base for new scenarios without the need to rescript the entire scenario.

- Build scenarios for accident remediation, employment pre-screening for new drivers and targeted training for existing drivers.
- Easily and affordably create training content for classroom presentations.
- Add new challenges to accommodate any trainer experience level.
- Present variation-on-theme to promote complexity within a training progression.
- View scenarios from any angle, including top-down view for vehicle positioning.
- Control the sequence and timing of event triggering.
- Create scenarios on a separate PC and transfer the information to the simulator with a flash drive.
- Compatible with any standard desktop or notebook PC with 3D graphics capability.

Scenario Builder will enable the instructor to determine vehicle characteristics such as vehicle type, rate of speed, directional bearing, and other attributes. The interface will be used to define the behaviors, decisions, and interactions that will occur between the scripted vehicles, pedestrians, and student-operated vehicle. The route each vehicle and dynamic pedestrian will travel is under the expressed control of the instructor. All aspects of the scenario can be determined by the instructor to ensure that the desired intend of the prescribed training will be met.

Scripted scenarios are an important component of a standardized training program in that each scenario is repeatable and will convey a consistent delivery of the prescribed lesson for each participant.

Scenarios can be modified so that changes can be made and saved to create variations that will keep the content fresh and challenging from one year to the next. Scenarios will remain stored at the instructor station. Libraries can be built quickly by modifying existing scenarios to create new lessons.

Replay Studio™ After-Action Review

The instructor station can record training scenarios so that they can be replayed. Replay can be viewed from multiple eyepoints, including those of the driver, a third person, and multiple bird's-eye views.

The playback of any recording recreates all of the original training exercise cues, including audio, visual, and vehicle states. After playback of an exercise, the instructor can reload the same scenario, or load a new exercise. Student scoring records can be displayed and printed as part of the replay. The replay control window shows violations, provides a slider bar to quickly move to any point in the scenario, and allows the instructor to change viewing (camera) angle, while providing complete control over the replay.

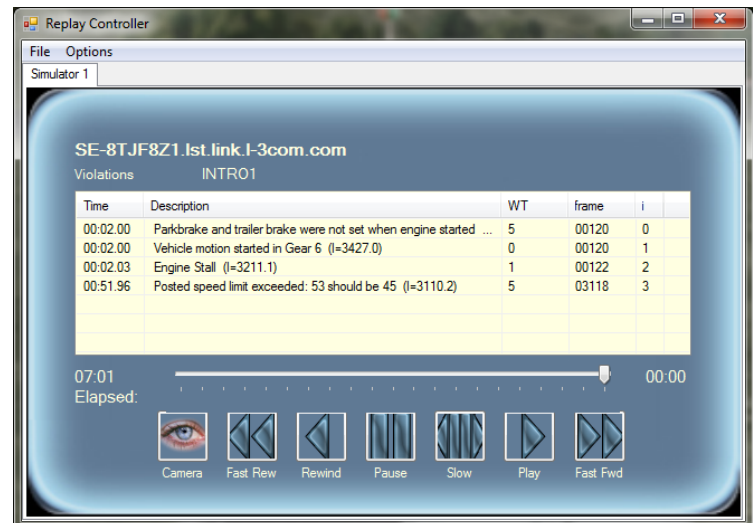

The instructor can activate the replay mode at any time during the scenario. The instructor can pause or freeze the scenario during the training session and resume training from the point where the scenario was frozen. When the scenario is frozen, the instructor can play it back using the replay mode, exit the scenario, and provide student performance analysis. The instructor can also click on a scoring violation or event to go directly to that point in the replay or use the slider control to quickly move through the replay.

Replay Tools and Features

- **Violations display** lets you select a violation (or other event) in the list box to move to a point in the replay five seconds prior to the selected event. Replay lead time can be modified to zero seconds with the **Options** button on the Replay tool.
- **Slider Bar** rapidly moves the scenario to any point in the recording.
- **Camera** steps the replay eye point through different positions relative to the own cab.
- **Fast Rew** quickly rewinds the scenario.
- **Rewind** rewinds the scenario at normal speed.
- **Pause** pauses the scenario.
- **Slow** runs the scenario at slow speed.
- **Play** plays the scenario at normal speed.
- **Fast Fwd** quickly forwards the scenario.

In-Cab Camera Displays

An integrated camera records the student's position, facial expressions, and hand reactions. This video feed is used to provide training feedback. In addition, the camera shows a live image at the Instructor Operator Station for observation. During low-light situations, the camera will automatically switch to black-and-white, infrared mode to maintain a high-contrast, crisp image of the driver.

The video feed can also be recorded for after-action review (AAR). Video is played back during AAR in complete synchronization with the out-the-window view of the recorded driving actions. This allows the instructor to review the actions taken during the scenario as the driver experienced it, as well as review the video of the driver's face and hands. AAR playback can also be paused and indexed forward and backward in time. The instructor can also click on a scoring violation to go directly to that point in the replay.

The video replay is automatically synchronized with the simulator graphics and audio.

Learning Management System (LMS)

The Lesson Management System (LMS) allows the instructor to create, manage and load lessons, lesson plans, organize classes and students, and back up the student database.

Student and Assessment Manager

The Student Manager allows the instructor to:

- Create and manage training classes.
- Create and manage the student database.
- Assign students to training classes.
- Delete Class – removes the class from the list of classes and the LMS database.

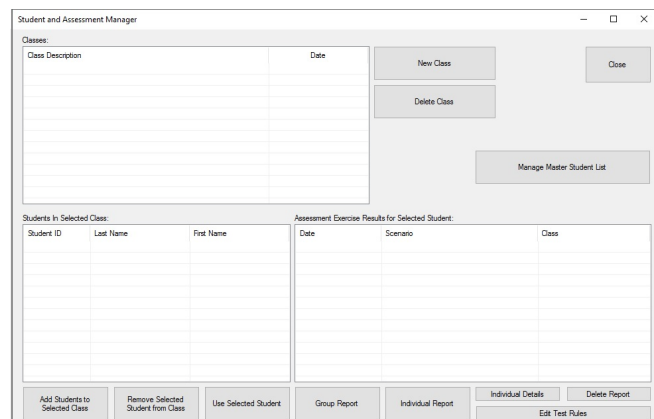

Lesson Plan Editor

The lesson plan editor provides a menu-driven interface for the creation or modification of lesson plans. The Lesson Planner allows the instructor to create new lesson plans or modify existing lesson plans for use in a training session. Instructor can easily add and remove scenarios that are part of the curriculum package and learning objectives for the lesson plan.

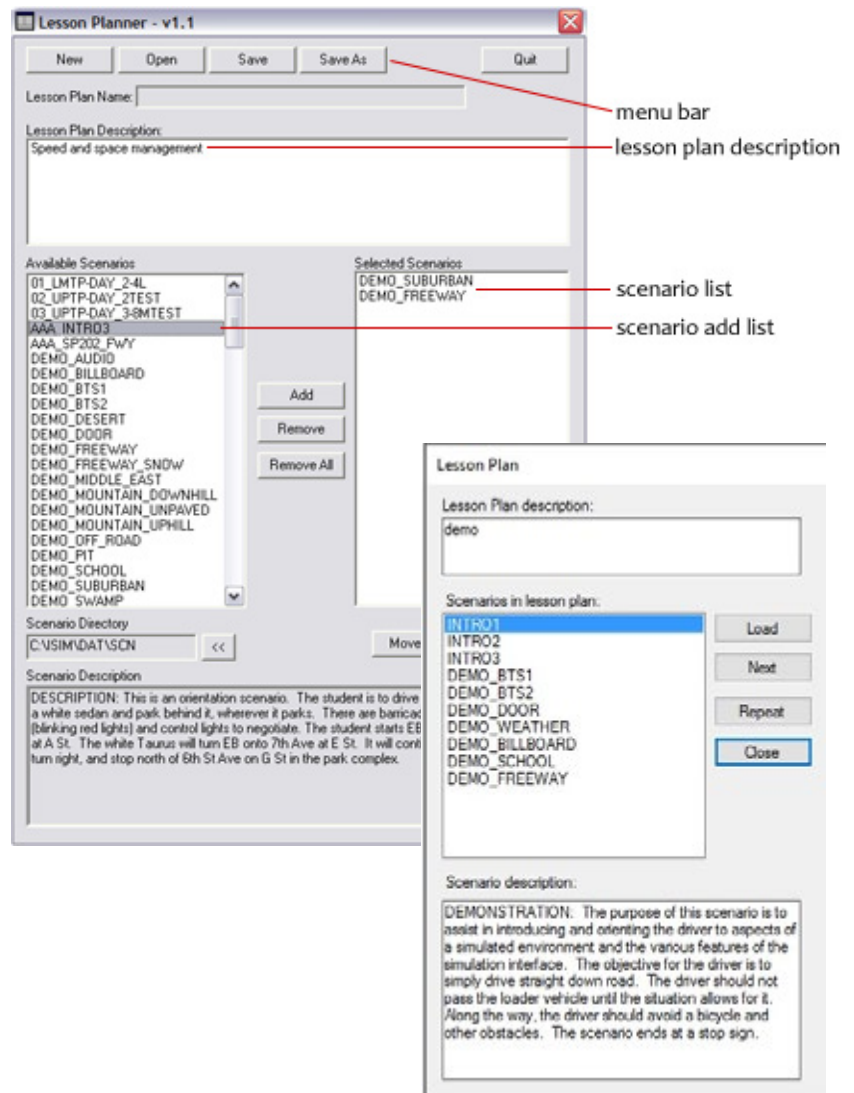

Assessments Viewer

Access a centralized list of all assessments created and stored on the system for easy access. The Assessment Viewer also gives instructor access to the test parameter settings for the loaded assessment

Backup Database

The backup utility allows the student and lesson records to be backed up to a file locally on the instructor station or it can be offloaded to an external device.

Basic Scoring Report

The simulator software can automatically collect scoring data from a scenario. After a student’s simulated drive, the software generates a report indicating the individual strengths and weaknesses of each driver.











The instructor can use this report to determine which drivers are most in need of training and which areas of training would be most beneficial to them.

- After data has been generated, it can be copied, archived to other locations, or purged.
- These reports offer limited editing, allowing test parameters to be enabled/disabled and violation point values to be adjusted.
- The tests include collisions, speeding, following too close, hard braking, and other factors that influence driver performance.
- Scenarios and performance data can be managed in clusters, such as lesson plans, date and location of training, and the student’s organizational unit.

Basic Scoring Data Captured

The following general information is captured for each student exercise, at a minimum:

- Driver ID
- Date and time
- Owncab vehicle model
- Exercise name
- Length of drive: distance and time
- Number of violations
- Number of warnings

SIMULATOR DRIVE REPORT	
Scenario Info	
Item Name	Value
Overall	
Scenario Name	INTRO1
Driver Id	111
Driver Name	John Doe
Exercise ID	EXID_43_111_INTRO1
Date	06/25/14
Time of Day	14:38:59
Vehicle Model	CM390F9TLR
Trip Distance	0.84 Miles
MPG	3.92
Test File Name	C:\SIM\DAT\DPS\DPSTruckingTests.xml
Number Of Tests Defined	12
Scenario Length	1:27
Total Violations	6
Total Warnings	1
Total Deductions	36
Minimum Passing Score	0 / 100
Actual Score	64 / 100
Event Summary	
Description	Importance
Startup Procedure (2 Violations, 0 Warnings)	
Park brake was not set when engine started [-5]	
(Information: Vehicle motion started in First Gear (2))	
Motion started when brake air pressure was low [-5]	
Description	Importance
Speed Management (3 Violations, 1 Warning)	
Over Speed Limit (2) [-10]	
Engine Stall (Warning) [-1]	
Hard Braking [-5]	
Description	Importance
Space Management (1 Violation, 0 Warnings)	
Collision [-10]	
Event Detail / Notes	
Time	Description
0:13	Parkbrake and trailer brake were not set when engine started
0:13	Vehicle motion started in First Gear (2)
0:13	Motion started when brake air pressure was low
0:45	Posted speed limit exceeded: 53 should be 45
1:05	Maximum Speed Limit Exceeded 67 should be 65
1:06	Cab collided with a structure (100038) , Speed: 68 Mph
1:16	Hard braking; Initial speed = 70.40 MPH
1:19	Engine Stall
ScoringSummary.xml rev. February 4, 2014	
Copyright 2014 L-3 Communications	

SkillSet™ Performance Assessment

SkillSet™ Performance Assessment software is an automated, objective-based driving assessment system. Through proper assessment and training, drivers can improve their decision-making process and become skilled at recognizing and managing risk. The SkillSet™ Performance assessment offers:

- Instantly replay, review, and discuss a driver’s performance.
- Clearly define criteria to facilitate standardized, objective-based assessments.
- Consistent, tangible results across multiple instructors
- Tailor training to improve individual aptitude or group certification.
- Optimize training time - Instructors spend more time instructing and less time capturing results.
- Group reports facilitate evaluation of individuals, relative to the group.
- Easily and accurately capture and document training data.

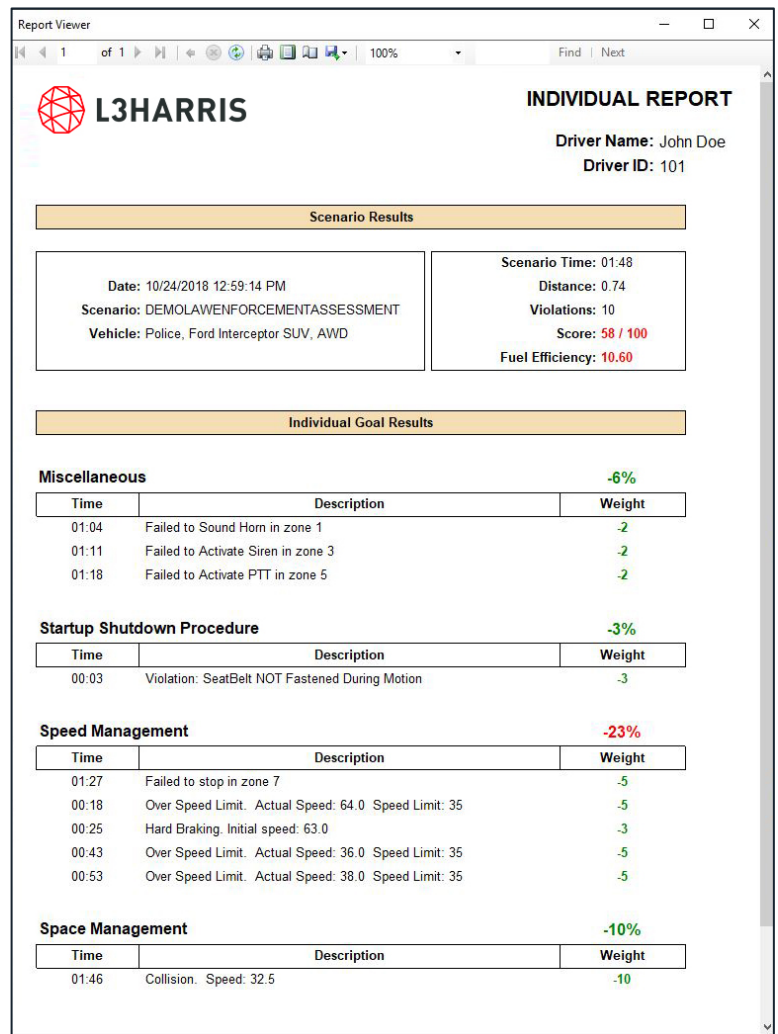

Report Viewer

L3HARRIS

INDIVIDUAL REPORT

Driver Name: John Doe
Driver ID: 101

Scenario Results

Date: 10/24/2018 12:59:14 PM	Scenario Time: 01:48
Scenario: DEMOLAWENFORCEMENTASSESSMENT	Distance: 0.74
Vehicle: Police, Ford Interceptor SUV, AWD	Violations: 10
	Score: 58 / 100
	Fuel Efficiency: 10.60

Individual Goal Results

Miscellaneous -6%

Time	Description	Weight
01:04	Failed to Sound Horn in zone 1	-2
01:11	Failed to Activate Siren in zone 3	-2
01:18	Failed to Activate PTT in zone 5	-2

Startup Shutdown Procedure -3%

Time	Description	Weight
00:03	Violation: SeatBelt NOT Fastened During Motion	-3

Speed Management -23%

Time	Description	Weight
01:27	Failed to stop in zone 7	-5
00:18	Over Speed Limit. Actual Speed: 64.0 Speed Limit: 35	-5
00:25	Hard Braking. Initial speed: 63.0	-3
00:43	Over Speed Limit. Actual Speed: 36.0 Speed Limit: 35	-5
00:53	Over Speed Limit. Actual Speed: 38.0 Speed Limit: 35	-5

Space Management -10%

Time	Description	Weight
01:46	Collision. Speed: 32.5	-10

Skillset™ helps the instructor identify the strengths and weaknesses of individual drivers and hone in on areas requiring the most need for improvement. The results of the Skillset™ assessment can also be viewed individually or as a group and can identify skills that require further training. Students are evaluated on how effectively they have mastered handling of their vehicle, scanning and hazard detection, and compound tasks like radio commentary with dispatch or other officers.

Scoring Criteria Always Being Monitored:

- Following distance (includes audible and visual warnings)
- Collisions
- Speeding
- Hard braking
- Failed to use hazards while in reverse
- Failed to fasten seat belt
- Improper acceleration
- Steering input while stopped (scrubbing the tires)
- Rolled over
- Vehicle moving prior to engine start
- Excessive speed in reverse
- Park brake not set prior to engine start

Compound Test Items

A Compound Test item is a group of test items, perhaps better referred to as a Learning Objective. The purpose of compound test items is to organize test results in terms of various general skills the student is expected to acquire. The available compound test items for the basic commercial vehicle tests include, among others:

Startup / Shutdown Procedures	Speed Management	Space Management
<ul style="list-style-type: none"> ➤ Brakes released prior to start of motion ➤ Vehicle rolling in neutral ➤ Engine start <ul style="list-style-type: none"> ■ Not in Neutral gear ■ Park brakes not set ➤ Engine stop ➤ Park brakes not set ➤ Motion start <ul style="list-style-type: none"> ■ Engine not running ■ Park brake or trailer brake set (Exception: tug test with trailer brake set) ■ Footbrake not applied ■ Air pressure too low ➤ Seat belt not fastened ➤ Initial gear selection 	<ul style="list-style-type: none"> ➤ Speed limit violations ➤ Engine stall ➤ Vehicle rolling at any time (e.g. in Neutral or with clutch depressed) ➤ Riding brake 	<ul style="list-style-type: none"> ➤ Following distance violations ➤ Improper lane position ➤ Collision ➤ Hard braking

A **Generic** category is also available which allows miscellaneous test items to be created by the user, embedded in the scenario script. Any condition that can be detected in an exercise can be recorded as a test event, scored, etc.

The Individual Report

The Skillset™ Assessment produces an “Individual Report”. All important information is summarized on a single page. This single-page report format is intended for use by the instructor and student, and is available immediately at the conclusion of a simulation exercise. This report is user friendly, easy to understand, and can be viewed, printed, and archived on the IOS computer. This report addresses the following user needs:

- Indication that the student completed the exercise successfully, OR
- Clearly indicate skills which have not been mastered by the student, and need additional work
- Reward the student for successful completion of a test by providing a single page format which is printable and easily understood by teacher and student

All of the parameters of the Individual Report have reasonable default values. Those parameters likely to be modified frequently are editable by end-users, by means of one or more user-friendly tools.

The Group Report

The Skillset™ Assessment also produces a “Group Report”, which shows the combined performance outcomes for all individual reports which have been viewed within a specific class.

Real Time Reporting

While the student is driving in the simulator, the Replay Control software reports violations, warnings, and other events as they occur. A recording file can be saved, and replay can be started at a point just prior to any violation. A scroll bar allows the instructor to move quickly to any point in the recording.

Modification of Test Parameters

All of the parameters used in student testing have reasonable default values, but are also modifiable by L3Harris. Some of the parameters most likely to be modified frequently are exposed in data files that are editable by end-users.

Report Generation

Reports are generated by a process of filtering all captured data, and presenting results in a user-friendly form. For basic student reporting, reports are available in a single page “bubble” report format, as seen in the figure above.

Training Data Security, Storage and Retention

Type of data tracked and required by the system:

- No student or training data is technically required by the system in order to operate.
- **LMS:** If the customer wishes to utilize the Lesson Management System (LMS) it allows the instructor to create, manage and load lessons, lesson plans, organize scenarios, organize classes and students, and back up the student database.
- **Scenario Builder:** If the instructor wishes to add, edit, or create new training scenarios using Scenario Builder than those scenarios are stored and managed by the customer as they see fit.
- **Assessments Reports:** a centralized list of all assessments are created and stored on the system for easy access. The Assessment Viewer also gives instructor access to the test parameter settings for the loaded assessment. The parameters are typically preloaded, but if the customer wishes to make any changes to the weighted scores or rules than they become custom data that the customer can backup.

Training Data Type: Training data typically entered in to LMS includes the following variables:

- Create and manage training classes (date, location)
- Create and manage the student database
- Assign students to training classes
- Driver ID
- Date and time
- Owncab vehicle model
- Exercise name
- Length of drive: distance and time
- Number of violations
- Number of warnings
- Data for individual scenarios includes locations, time stamps, scores, and violations based on the environment, conditions and criteria for each scenario

Type of data retained:

- Purpose of the retained data: There are no requirements for data retention. It is up to the customer to decide to retain or purge training data after each class or training session.

- Retention period: Not restricted. Can be managed and set according to customer's IT or HR retention policies. Depending on the number of students, frequency of classes, and the retention policy for training records training recording files can take up hard drive space over time. Although not required, it is recommended that the simulator system be provided a large enough external network area storage (NAS), mapped network drive, or local hard drive backup capability that is available on the customer's network and abides by the customer's IT policies.
- Storage location: All simulator training data is stored locally on the simulator system hard drives.
- Data Retrieval Method: All data is accessible locally on the IOS station so it is readily available with minimal need for additional integration or retrieval methods.

3 | PRODUCT OPTIONS

L3Harris offers a number of options, including hardware and software options, curriculum, training, customization, and mobile solutions, to enhance and extend the performance and capabilities of your TranSim™ driving simulator. Please contact your L3Harris representative with any pricing or configuration questions.

3.1 Hardware Options

3DOF Motion Base

The 3DOF full motion system, consists of a set of 4 electronic motion actuators installed onto the base of the driving compartment. This system provides accurate and realistic per-wheel motion from the scenario including bumps, road surface vibrations, acceleration and deceleration, engine vibrations, and vehicle motion cues. Motion is provided for the entire seat base (seat, steering wheel, transmission, pedals, dash, etc.) not just the seat. This provides a much more realistic range of motion than a typical “rumble seat” and creates a much more immersive simulated environment as well as a better over-all training experience.



- 120Hz update frequency
- 4 independently-controlled motion actuators
- 1000lb capacity
- Available for both stand-alone or trailer-mounted simulators

Student/Instructor Radio Communication System

L3Harris offers an optional single-channel two-way radio system with instructor headset and student mic system that allows the instructor to act as dispatch and communicate instructions to the student during training scenarios. The student has access to a magnetic mic clip that can be mounted to the dash to communicate back to the instructor their location or other information. A custom software app runs on the IOS to manage the radio system and allows the instructor to switch communications between simulators if it is setup for a multi-simulator

networked configuration. Voice communications are recorded as part of the ReplayStudio recording file for after action review.

Rabbit Station

The Rabbit Station is an instructor-controlled decoy vehicle station, operated from the instructor operator station. The Rabbit Station provides the trainer with the ability to control (in real time) objects in the scene. The instructor can take control of any moving entity in the scene including vehicle, animal, pedestrian, etc. The Rabbit Station operator is able to see and interact with any trainee who is driving the scenario-controlled-vehicle. The steering wheel and accelerator pedal control forward speed and steering. Top-level radar display of the Rabbit Station vehicle is used for navigational and interaction purposes.



Rabbit Station Controls

3.2 Software & Vehicle Options

Numerous options are available to increase the capabilities of your simulator beyond its standard feature set. These options have been designed to provide specific sets of capabilities and meet the needs of specific requirements. Software options are sold on a per-IOs basis to reduce costs for those using multiple simulators.

Trucking Vehicles Expansion Package

The Trucking Vehicles Expansion Package significantly increases both the number and types of drivable vehicles and related scenarios for use on your TranSim™ simulator. These additional vehicles are categorized into their relevant types below.

Ready-Mix Concrete Trucks with Scenarios

Two own-cabs (front discharge and rear discharge cement mixer trucks), vehicle dynamics data, a custom Glass Dash, and three scenarios. Scenarios occur in the suburban driving environment and allow the student to demonstrate speed and space management, react to various traffic hazards, and anticipate and avoid potential hazards through situational analysis.



- Concrete Truck Front Discharge, 335 HP, 6-speed automatic transmission



- Concrete Truck Rear Discharge, 440 HP, 6-speed automatic transmission
- Concrete Truck Rear Discharge, 400 HP, 9-speed manual transmission

Automotive Transport Hauler

Three different ownfabs with appropriate glass dashes, each able to be driven empty or loaded. The student experiences the unique driving challenges involved with hauling cars.



- Peterbilt, Cat 475 13-speed, manual transmission, Boydston trailer, empty/full



- Peterbilt, Cat 430 10-speed, manual transmission, Cottrell trailer, empty/full

- Sterling, Cat 430 10-speed, manual transmission, Cottrell trailer, empty/full

Municipal Vehicles

Includes common municipal and utility types of vehicles and configurations.



- Chevy Silverado Utility, 300 HP, 4 speed automatic transmission



- Ford F450 Bucket Truck, 300 HP, 5 speed automatic transmission



- Peterbilt Bucket Truck, 450 HP, 6 speed automatic transmission



- Freightliner Derrick Truck, 450 HP, 6 speed automatic transmission



- Utility Pole Trailer, pulled by Freightliner Derrick Truck



- 'Ditch Witch' Trailer, pulled by Chevy Silverado Utility truck



- Freightliner Line Truck, 450 HP, 6 speed automatic transmission



- SWAT Command Vehicle, 300 HP diesel engine, 6 speed automatic transmission



- Dump Truck, 10 Wheel, 500 HP diesel engine, 6 speed automatic transmission, 3 axles
- Dump Truck, 6 Wheel, 460 HP diesel engine, 9 speed manual transmission, 3 axles
- Dump Truck, 6 Wheel, 500 HP diesel engine, 6 speed automatic transmission, 3 axles



- Fire Truck, Red, 500 HP diesel engine, 10 speed automatic transmission



- Fire Truck, Yellow, 500 HP diesel engine, 10 speed automatic transmission



- SWAT Support Vehicle, 300 HP engine, 5 speed automatic transmission



- SWAT Step Van, 4 speed automatic transmission

Oversized Load Vehicle with Scenarios

This package includes 2 vehicles, each pulling a lowboy trailer with an oversized construction object on it. It also includes 2 freeway scenarios to help train drivers in oversize load situations with upcoming exits, reckless vehicles, low bridges, etc.



- Freightliner, Cummins 390, Fuller 9
- Freightliner, 10 speed automatic transmission



- Lowboy Oversized Trailer

Solid Waste Vehicle

Includes a garbage truck with specialized dashboard and allows the student to practice safe trash collecting techniques, including; daily hazard awareness, like backing up, cul-de-sac collection, pedestrian and bicycle traffic. Reduced visibility due to weather and environmental conditions, and speed and space management, including crossing traffic, yielding, passing, and merging.



- Garbage Truck, 500 HP diesel engine, 10 speed automatic transmission, 3 axles

Delivery Fleet Vehicles

Three delivery own-cabs, including moving van, step van, and delivery tractor and trailer(s). One, two, or three trailers can be towed.



- Chevy Express Utility Van, 285 HP, 6 speed automatic transmission



- Ford Transport Van, 136 HP, 4 speed automatic transmission



- Freight Vehicle, 445 HP diesel, 10 speed automatic, 2 axles, 0, 1, 2, or 3 trailer pups
- Freight Vehicle, 430 HP diesel, 9 speed manual, 4 axles, 2 Freight 28' trailers
- Freight Vehicle, 500 HP diesel, 10 speed manual, 5 axles, 3 28' trailer pups
- Freight Vehicle, 390 HP diesel, 7 or 9 speed manual, 2/3 axles, 0 or 1 28' trailer pup
- Freight Vehicle, Cummins 390 HP, Fuller 7 or 9 speed manual, 2/4 axles, 0 or 1 28' trailer pup



- Step Van, 5 speed manual transmission
- Step Van, 4 speed automatic transmission



- Moving truck, 235 HP, automatic transmission



- F250 Superduty pickup, 300 HP V8

Bus Vehicles Package

The Bus Vehicles package consists of 10 ownrcabs, including a city transit bus, a school bus, a shuttle bus, and a motor coach. The Transit Bus includes a manual-transmission (10-speed) bus intended for a simulator with a manual transmission. Also includes ten additional scenarios. Scenarios include environments such as freeways, suburban environments, with situations for training backing, passing and lane changing, space management, turns and intersections, and dealing with bad weather.

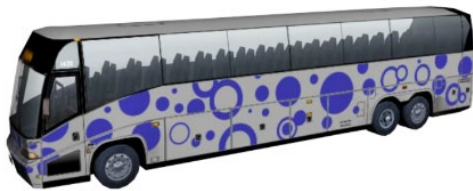

- Motor Coach, 455 HP, 10 speed manual



- Articulated Bus, 400 HP, 6 speed auto



- Transit Bus, 300 HP, 6 speed auto



- School Bus, 300 HP, 6 speed auto



- School Bus – Flat End, 300 HP, 6 speed auto



➤ Grey Bus, 300 HP, 6 speed auto



➤ Bluebird Type C School Bus, 300 HP,
6 speed auto



➤ Gillig 40' Low Floor Transit Bus, 325 HP,
4 speed auto



➤ New Flyer Transit Bus, 300 HP, 6 speed auto



➤ Shuttle Bus, 300 HP, 6 speed auto

Snowplow Package

Snowplow Vehicles & Scenarios

The optional Snowplow software package for TranSim™ includes training scenarios and vehicle combinations. This package is available with or without a set of hardware levers (see below). Includes introductory, intermediate, and advanced scenarios in either a snowy freeway or mountain-driving environment. The snow is visually cleared from the road by the snowplow, allowing the driver to check his progress. Two separate drivers can drive the advanced scenarios at the same time in separate simulators for coordination and communications training between the lead- and following-driver. The vehicle combinations provided by the Snowplow package include versions with front and right blades, front and left blades, wingblades, towplow, and automatic and manual versions of each.



Virtual Snowplow Controls

In the absence of the optional physical snowplow levers, a set of virtual controls on the touch screen can be used to accomplish the same tasks.

- Left, Center, and Right buttons control the angle of the front plow
- Front Up/Down controls the front plows up and down position
- Wing Up/Down controls the wing plow (left or right depending on vehicle)
- Spreader On/Off controls the salt spreader
- Blast when pressed stays in for 10 seconds for the blast effect



Skillset Assessment for Snowplow

Included with the Snowplow software package is assessment software that provides an additional scenario, and allows for the collection of advanced scoring data for all snowplow scenarios. This data includes speed limits, following distance, startup/shutdown procedures, speed management, space management, etc. Users can score each drive, save scores, and print reports.

Snowplow Hardware Controls

A set of joystick levers can be purchased in addition to the snowplow software. The joysticks are mounted on the right side of the simulator, are programmed to work with the snow plow software package, allowing raising and lowering of all blades, panning of the front blade, and activation of the sand spreader.



Virtual Environments Package

The Virtual Environments software package provides a number of additional driving environments as well as some additional scenarios and drivable vehicles.

Desert Environment

The desert environment covers a 9km x 7km area of flat terrain, subtle elevation changes, and limited vegetation. Students practice driving on paved roads, unpaved roads, dirt roads, and open areas free of roads or trails.



Dirt Road Environment

This package provides four dirt road scenarios that incorporate woods, steep grade changes, and narrow areas. Note that it is not intended for off-road driving.



Airport Environment

The airport environment includes a generic airport with runways, taxiways, a terminal, and gates. Also included are baggage tugs and cart scenario vehicles, as well as 3 scenarios.

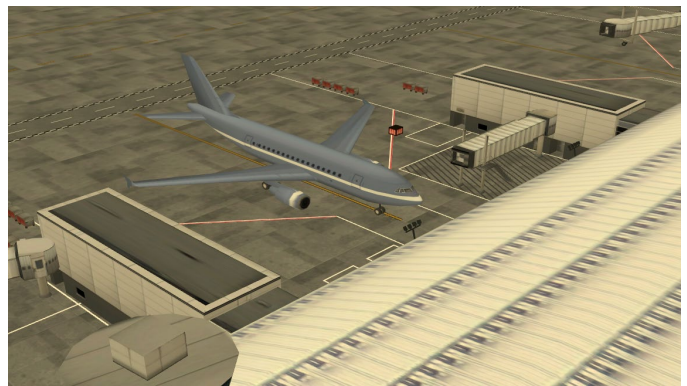

Indoor Trucking Course

This course teaches students how to manage driving a semi-tractor / trailer in small areas. The scenarios include lessons on subjects such as ‘completing a 9-point turn’ and ‘backing up in very tight spaces’. This package includes a cone course.



Swamp Environment

The swamp environment offers numerous challenging driving situations, including driving on dirt roads or muddy roads, maneuvering through standing water and washed out areas, manipulating road debris like logs and trenches, and managing narrow bridges.

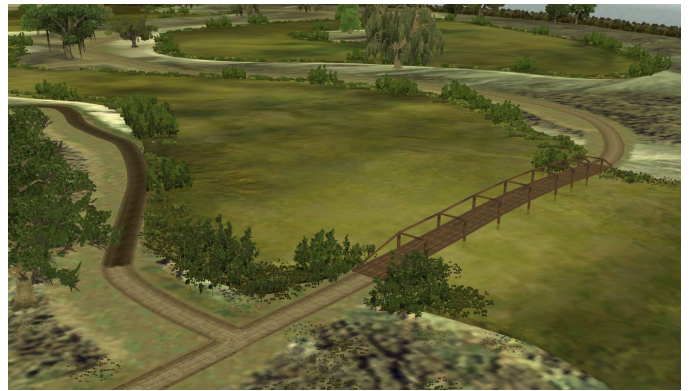

Mountain Forest

This mountain forest environment provides over 30km of smooth, washboard and rough dirt roads. It also includes three two-lane bridges.



Oil Field

The oil field environment provides multiple oil field operations in various stages of development, connected by a network of dirt roads. Several oil industry related placeable objects are also provided.

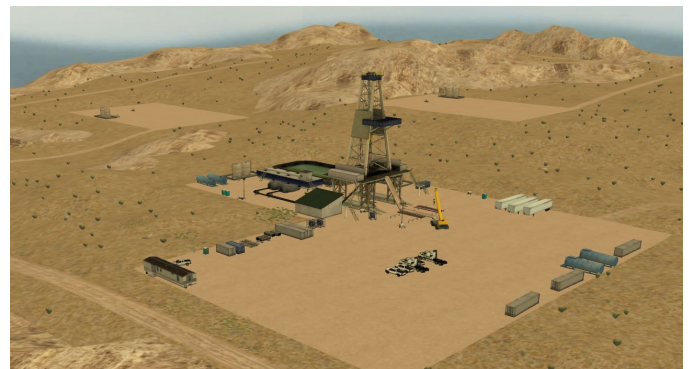

Maritime Container Port

The port environment provides multiple container cranes in a container port setting. Drivable yard trucks are included, as well as placeable container stacks, etc.

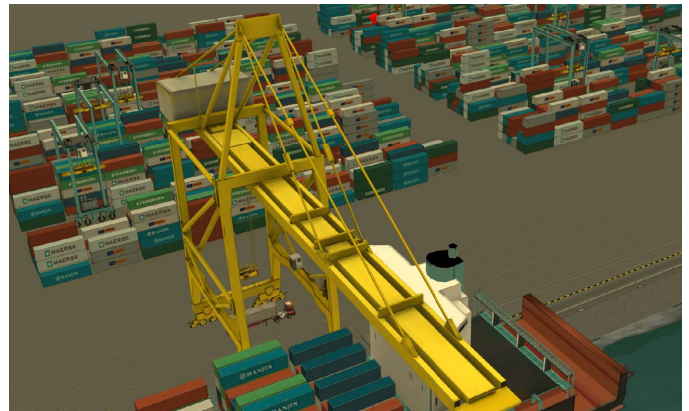

Coal Mine

The coal mine environment provide an operations center and two active pits, with roads that connect them all and allow terraced access into the pits.

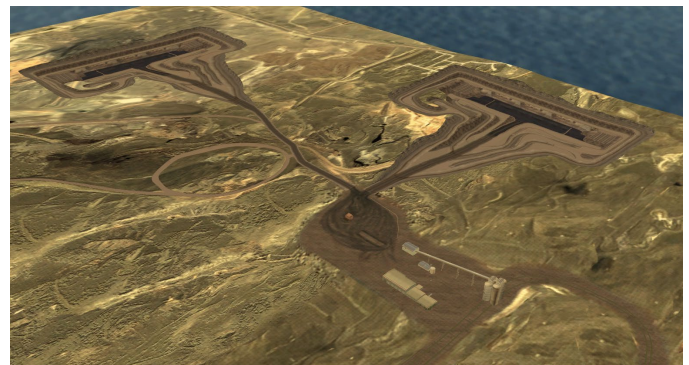

International Options

Options are also available to enable the International use of your simulator. Contact L3Harris for more information about these options.

- **Metric:** Converts all road signs in all databases to Canadian metric signs. It also changes the dashboards of all own-cabs, making KPH the default. This is intended only for vehicles in which the driver's seat is on the left.
- **Right Hand Drive (RHD) Option:** Provides a selection of the existing environments and scenarios setup for driving on the left hand side of the road, with the driver on the right hand side of the vehicle.
- **Spanish Software Option:** A Spanish language translation of much of the software, as well as an additional driving environment is provided.
- **Arabic Software Option:** An Arabic language translation of much of the software.
- **Power Adapter Options:** various power converters and adapter options are available to accommodate international power requirements.
- **Middle East Environment:** Provides an environment with a distinct Middle Eastern look and feel with signs and roadways that are specific to the region.

3.3 Mobile Training Center

As an alternative to a fixed site, you may wish to have the capability to easily move your simulator(s) to other locations to manage the challenges of training 'surges', events, or geographically diverse driver populations. We can put your simulator(s) in a fully-equipped trailer, creating a mobile training center. We offer both 24 and 42 foot trailers to allow you to deliver training capacity anywhere you may need it. *Truck not included.



3.4 Professional Services

In addition to the product options listed above, our services team can help develop a custom content or customize your TranSim™ in a variety of ways. We can develop customized training topics and curriculum, environments, help you develop scenarios, or create custom vehicles.

Vehicle Development Services

While your simulator comes with a large variety of vehicle types and configurations, our team can also develop vehicles exactly like those you use, including custom logos or graphics. This allows you to customize your simulator to portray the exact vehicles you use every day. Services including modelling, texturing, rigging, testing and validating vehicle dynamics data.

Consultation Services

Our consultation and development services include initial training needs analysis, the design and development of custom curriculum solutions that are based on specific learning objectives, delivery of training by qualified and experienced instructors, and comprehensive evaluation of driver skills and knowledge. We can also assist customers in measuring the performance of their drivers and ensure that return on investment is realized on all training efforts.



Training Services

In addition to custom training engagements, we also offer standard pre-defined training service packages for various types of training needs. These include Entry-Level & Onboarding Driver training, Post-Incident Safety Training, Safety Refresher Training, and Basic & Advanced Snowfighting. Our training services team will come to your site with everything needed to provide effective training including a mobile or fixed site classroom, simulators, curriculum, courseware, and experienced instructors. This cost-effective approach to training allows you to get the training you need, when you need it, without having to manage it yourself. Contact us for more information.

FAST. FORWARD.

TranSim Product Guide

© 2021 L3Harris Technologies, Inc. | 2021.12

This material consists of L3 Technologies, Inc. general capabilities information that does not contain controlled technical data as defined within the International Traffic in Arms (ITAR) Part 120.10 or Export Administration Regulations (EAR) Part 734.7-11. Data, including specifications, contained within this document are summary in nature and subject to change at any time without notice at the discretion of L3 Technologies, Inc. Call for latest revision. All brand names and product names referenced are trademarks, registered trademarks, or trade names of their respective holders.

