



Product Catalogue

CAD/CAM Solutions & Projects for Education



ISSUE 1



Denford are the proud sponsors of:



Welcome

to the latest edition of the Denford Product Catalogue - CAD/CAM Solutions & Projects for Education

As you will be aware, Denford is a British manufacturing company, which has been located in West Yorkshire for over 70 years, with a current product portfolio including a range of CNC milling machines, lathes and routers, together with lasers and 3D printers. These Denford products are a familiar feature in schools, colleges, universities and training centres around the world, as we continue to support the delivery of the STEM-based curriculum (Science, Technology, Engineering and Maths) in educational establishments worldwide.

Denford's on-going commitment to making a difference within the education sector is demonstrated by our involvement in several unique educational projects, including the F1 in Schools STEM Challenge, which was launched in the UK in 2000 as a Design & Technology project, and is now acknowledged as the world's most exciting STEM-based educational project, engaging with learners through the magnetic appeal of Formula 1.



Along with our traditional range of products, this latest issue of our Product Catalogue includes some exciting new products and concepts:

F1 in Schools Race Equipment - designed and manufactured in the UK by Denford.

Denford is delighted to be the official supplier of F1 in Schools Race Equipment and has developed a complete range of cutting-edge equipment to support the F1 in Schools Challenge, including a lightweight, portable Race Track and a Start Gate with clear display and data storage. This range of equipment was launched at the World Finals in Malaysia in 2017 and continues to be enhanced and developed to meet the technological demands of the competing students.

F1 in Schools STEM Studio - a complete, instant solution for engineering education.

The F1 in Schools STEM Studio is an innovative concept - developed collaboratively by F1 in Schools, Denford and Technology Supplies - offering high-quality equipment and resources within a dedicated stand-alone classroom workshop. This fully-resourced facility offers teachers the opportunity to deliver design & technology / engineering related courses, particularly those in remote locations or where lack of space may be a restriction.

We hope that you will enjoy our new Catalogue and thank you for your continued support.

Please feel free to contact us at info@denford.co.uk if you would like additional information on any of our products, services or educational projects.

Yours sincerely

Steve Oddy
Managing Director

denford.co.uk

 Like us
www.denford.co.uk

 Follow us
[@DenfordHQ](https://twitter.com/DenfordHQ)

WHAT TO LOOK OUT FOR...

NEW

Denford Duo

See page 29.



A combined, entry-level CNC Milling and Turning Package, incorporating the Micromill 3 axis CNC Milling Machine and the Microturn 2 axis CNC Lathe, complete with tooling and software. An ideal introduction to CNC manufacturing – available with optional upgrade: universal bench complete with 2 x computer support extensions. Available at a special package price.

NEW

F1 in Schools Race Equipment

See pages 60 - 65.



Denford is delighted to be the supplier of official F1 in Schools Race equipment, designed and manufactured in the UK to meet the technological demands of competing F1 in Schools teams. Products include the new lightweight, portable Race Track and Start Gate with clear display and data storage.

Contents

PROJECTS

Denford - Proud Founders & Sponsors of:

F1 in Schools STEM Challenge	4 - 5
Jaguar Primary School Challenge	6
Land Rover 4x4 in Schools Technology Challenge	7

MACHINES

PCB Engraver	8 - 9
Compact 1000 / 1000 Pro	10 - 11
Router 2600 / 2600 Pro	12 - 13
Router 2600 ATC & Router 6600 ATC	14 - 15
Router 6600 / 6600 Pro	16 - 17

Routing Accessories:

Floating Head, Self Centring Vice	18
Dust Pro 100, Dust Pro 50.	18
F1 Car Fixture, Clamping Kit,	19
Large Format Vacuum Bed, Vacuum Pads.	19
EasySCAN 3D Scanner	20
4th Axis Programmable Rotary Fixture	21

VMC 1300 / 1300 Pro	22 - 23
Turn 270 Pro	24 - 25
Turn 370 Pro	26 - 27
Micromill / Microturn / Denford Duo	28 - 29
Universal Machine Benches	30 - 31
Refurbishment and Re-Warranty Package	32 - 33

SOFTWARE

LaserCAM 2D Design	34 - 35
QuickCAM 2D Design	36 - 37
QuickCAM Pro	38 - 39
VR CNC Milling 5	40 - 41
QuickTURN 2D Design	42 - 43
VR CNC Turning	44 - 45
Virtual Wind Tunnel Mk7	46 - 47

LASERS

VLS Series Lasers	48 - 49
Large Format VLS Series Lasers	50 - 51

PACKAGES

F1 in Schools Packages	52 - 53
------------------------	---------

CLASSROOM

F1 in Schools STEM Studio	54 - 55
---------------------------	---------

RESOURCE

Primary STEM Project	56 - 57
----------------------	---------

CONSUMABLES/RACE EQUIPMENT

Land Rover 4x4 Starter Kit & Track Elements	58 - 59
F1 in Schools Race Equipment & Consumables	60 - 65
Denford Consumables	66 - 69
Denford Tooling, Consumables & Curriculum Packages	70 - 74

3D PRINTERS

A range of 3D printers is also available - see separate brochures. Call to request further details.

Tel: +44 (0)1484 728000



in Schools
STEM Challenge



The F1 in Schools STEM Challenge

Denford Limited is proud Founder and Sponsor of the F1 in Schools STEM Challenge, which uses the high profile, glamorous and high tech world of fast cars and Formula 1 to engage with students, introducing them to engineering in a compelling and unique educational programme.

The programme, with its multi-disciplinary approach embracing key skills across STEM, can be used as an education tool to engage students in STEM subjects, while inspiring many students to consider engineering as a career. This gives both students and teachers the opportunity to develop key skills such as communication, presenting and team work, while forming the foundation for any career path students choose to follow. It develops their confidence through team work and verbal presentations needed in the judging elements and often sparks a passion for a specific expertise, whether this is managing people, marketing the team or creating artistic graphics and displays.



The challenge is aimed at students aged between 11-19 and is split into three Classes: Entry, Development and Professional. As students progress through the competition, standards and expectations rise, in preparation for the opportunities and challenges which will await them in their future careers.

F1 in Schools can be delivered as a stand-alone project in schools and clubs, or embedded into the curriculum as a full Level 2 qualification using teaching materials mapped to AQA and OCR Qualifications.

With F1 in Schools now operating globally in over 44 countries, it provides a real opportunity for a learning experience of a lifetime and the chance to become a World Champion.

The 14th F1 in Schools World Finals took place in Singapore in September 2018 alongside the FORMULA 1 SINGAPORE AIRLINES SINGAPORE GRAND PRIX. 51 teams competed for the F1 in Schools World Champions' Trophy and Horizon from Brighton Secondary School in Australia were crowned F1 in Schools 2018 World Champions.

Andrew Denford

Founder and Chairman, F1 in Schools Ltd

For further information please visit the following sites:

f1inschools.com 4x4inschools.com
primaryschoolchallenge.com

 Like us
@F1inSchoolsUK

 Follow us
@F1inSchoolsUK

 See us
@f1inschoolsUK

 Watch us
F1inSchoolsUK

The F1 in Schools STEM Challenge

The F1 in Schools STEM Challenge encourages students to explore a variety of engineering and manufacturing processes by using CAD/CAM and CNC technology to produce their own model F1 Car of the Future.

As Proud Founder and Sponsor of F1 in Schools, Denford is delighted to be the official supplier of F1 in Schools Race equipment - see pages 60 - 65.



1 - Form an F1 in Schools™ Team

A team is formed of three - six students, with a team name, allocated job roles: Team Manager, Manufacturing Engineer, Design Engineer, Graphic Designer and Resource Manager. The team then registers for the regional finals.

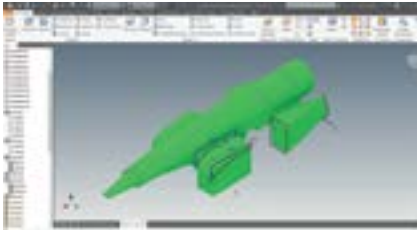

3 - Design AUTODESK

Using sketching and modelling, along with 3D CAD (Computer Aided Design) software, the team **designs** an F1 car of the future to the specification set by the International Rules Committee, just like in Formula 1.



5 - Make

Using 3D CAM (Computer Aided Manufacture) software, the team evaluates the most efficient machining strategy to **make** the car.



2 - Business & Sponsorship Plan

The team prepares a **business plan**, develops a budget and raises **sponsorship**. Teams are encouraged to collaborate with industry and create business links.

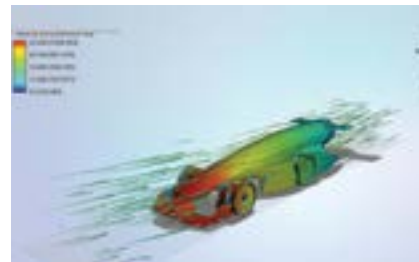

4 - Analyse AUTODESK

Aerodynamics are **analysed** for drag coefficient in a Virtual Reality Wind Tunnel using Computational Fluid Dynamics software (CFD).



6 - Test

Aerodynamics are **tested** in wind and smoke tunnels. Aerodynamics is a major focus for all teams involved in the world of Formula 1 and can make the difference to a winning team. Students can fine tune designs to optimise speed and drag co-efficiency.

7 - RACE !

Teams are judged on car speed, as well as supporting evidence of their design, verbal presentation and marketing display stand in "the pits".

Teams put the cars to their ultimate test by **racing** them over a measured 20m distance with the F1 Race Track and F1 Race Control System.

f1inschools.com



PRIMARY SCHOOL CHALLENGE

The Jaguar Primary School Challenge

The Jaguar Primary School Challenge (JPSC) engages with primary school students and teachers across the UK to give the chance for teams of 3-6 students to work and compete like a real racing team. The challenge is open to students aged 5-11 years old and involves designing and manufacturing the fastest car possible, emulating the design and engineering processes employed by real engineering companies, such as Jaguar Cars.

Students are challenged to form a team of 3-6 pupils and design a race car out of 160g/m² card, complete with wheels, body and even a mini driver. They will design and manufacture a body shell to fit a standard chassis, using template software, before printing/cutting their designs on to card and then making their car ready to race. Silhouette Cameo cutters used must be able to perforate but not score.

The Jaguar Primary School Challenge is sponsored and supported by Jaguar Cars, who have been Title Partner of the Project since 2013. Jaguar understand the need to encourage and motivate young people to develop key skills required for companies such as Jaguar to be successful in producing award winning vehicles.



JPSC offers primary school students the opportunity to:

- Take part in a fun hands-on STEM activity
- Tackle real life problem solving and learning
- Develop design, manufacture, team work, communication & business skills
- Be assigned a Jaguar Land Rover Mentor
- Take part in a UK Nationwide challenge

The rules and regulations are available to download from:

primaryschoolchallenge.com



ABOVE & BEYOND



The Land Rover 4x4 in Schools Technology Challenge

Inspiring the next generation of engineers with the practical challenge of designing and building their own radio-controlled all-terrain vehicles, this challenge captures the imagination of students, while providing teachers with the opportunity to run a real-life automotive design competition.

The challenge is split into three Classes: Entry, Development and Professional, and requires students to build a radio controlled four-wheel drive (4x4) vehicle to the specifications provided by the International Rules Committee. Teams navigate their vehicle around a bespoke Land Rover track replicating the capabilities of a full scale 4x4 vehicle. The course includes challenging road surfaces including water dips, rope and pipe bridges, rocks and steep inclines. Each team will enter their vehicle into a Regional Final to compete for a place at the National Final in their country. The National Champions from each country are then invited to compete at the Land Rover 4x4 in Schools World Finals. This experience will form the foundations of their future in any career path they choose to follow.



This exciting education initiative provides teachers with the opportunity to run a real-life competition with students, where they follow the same design processes as automotive engineers follow - from their initial business plan through to their car design.

This global challenge offers an exciting opportunity to encourage the development of the engineers of tomorrow, to engage young people in the complexities and challenges of design engineering, and to demonstrate the rewards of choosing engineering as a career.

The 3rd World Finals was held in Abu Dhabi in December 2017 with 23 teams competing for the World Champions' Trophy. K-EVO from Escola Secundaria de Ponte de Lima in Portugal were crowned the 2017 Land Rover 4x4 in Schools World Champions.

The challenge is open to young people between KS3-5 in schools, and 11-19 year olds in any out of school initiative, e.g. STEM Clubs, Scouts, Cadets, Guides and Youth Clubs. Teams can register via the competition website 4x4inschools.com and enter their team into a Regional Final to compete for a place at a National Final.

4x4inschools.com

**LAND ROVER 4x4 STARTER KIT
& TRACK ELEMENTS**

See Pages 58 - 59

PCB Engraver

3 AXIS CNC PCB AND ENGRAVING MACHINE



The PCB Engraver is ideal for manufacture of PCB boards.

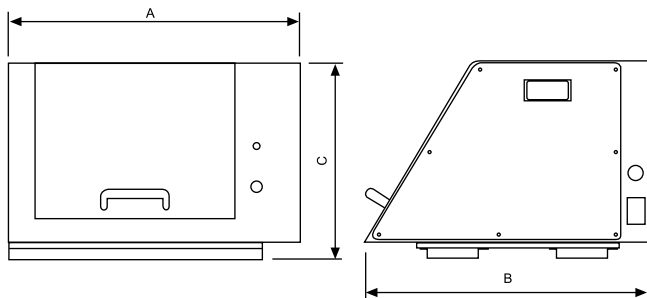

Machine Dimensions.

A 3 axis CNC PCB and Engraving Machine with totally-enclosed guarding, suitable for all levels of education and training. The PCB Engraver is supplied with operating software incorporating Gerber and DXF import facilities.

The PCB Engraver is ideal for cutting and engraving a range of resistant materials, including copper board, plastic and acrylic. Denford's PCB Engraving Machine features the latest 'Floating Head' technology. The floating head allows manufacture of PCB's, and engraving of uneven surfaces. The PCB Engraver is also ideal for batch manufacture of PCB boards.



PCB Engraver

Denford's PCB Engraver is ideal for schools wishing to move away from traditional methods of chemical etching of PCB boards.

THE PCB ENGRAVER COMES

AS STANDARD WITH:

- Powerful operating software that is simple to use and allows multiple designs to be made at once
- High speed spindle motor and floating head technology
- Basic tools and depth-setting device
- Outlet for dust extraction
- Sacrificial Table
- Installation and Instruction Manuals
- USB Connection

The PCB Engraver software will import Gerber files or CNC G-Code files. Third party PCB software is required to create Gerber files, and QuickCAM 2D Design software would be an ideal addition to create CNC G-Code.

Please Note:

- Dust extraction is essential to allow the machine to function. The DP-50 is ideal - see page 18.
- The machine spindle has a 20 minute 50% duty cycle, so use of additional spindle motors for tool changing will increase productivity.

Tool changes are a simple process and allow drilling of larger holes, and the adjustable spindle speed and feedrate make the PCB Engraver ideal for cutting or engraving a range of resistant materials such as plastic, acrylic and copper board. The floating head, combined with powerful new software, makes manufacture a quick and easy process.

QUALITY, PRECISION, MAINTENANCE FREE ROUTING

Denford supply CNC Routers with precision anti-backlash nuts/leadscrews, as they provide a highly reliable, accurate and almost maintenance-free solution and are perfect for use in a dusty environment. Anti-backlash nuts and lead screws provide a number of clear technical advantages:

- Zero maintenance / No lubrication required / Lower particulate generation / Longer life with non-catastrophic failure / Quieter operation [no re-circulating ball noise] / High helix / Fast leads / Zero-backlash with very light pre-load / low drag

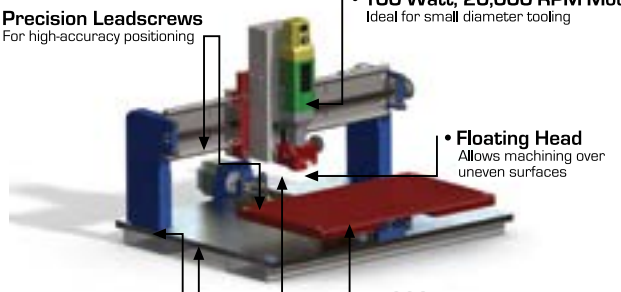
- 
- **Precision Leadscrews**
For high-accuracy positioning
 - **100 Watt, 20,000 RPM Motor**
Ideal for small diameter tooling
 - **Floating Head**
Allows machining over uneven surfaces
 - **5,000mm/min Fast Traverse**
For speed of manufacture
 - **Localised Dust Extraction**
Essential for accurate cutting with Floating Head
 - **Spare Spindle Motor is Available**
For quick and easy toolchange
 - **Rigid Construction / Solid Metal Base**
To improve accuracy & repeatability

Please note, diagram for illustration purposes only.

MECHANICAL DETAILS	PCB ENGRAVER
Machine Length (A)	570mm - 22.44in
Machine Depth (B)	585mm - 23.03in
Machine Height (C)	385mm - 15.16in
Machine Weight	43kg - 94.80lb
Table Size	360 x 210mm - 14.17 x 8.27in
Travel X Axis	330mm - 13in
Travel Y Axis	210mm - 8.27in
Travel Z Axis	40mm - 1.57in
Float Z Axis	5mm - 0.20in
Beam Clearance	50mm - 1.97in
Max. Spindle Speed	20,000rpm
Spindle Speed Control	Manual
Max. Feed Rate	5000mm/min - 196.85in/min
Max. Contouring Feed Rate	1000mm/min - 39.37in/min
Spindle Motor 110V/230V Supply	100W - 0.13HP
Axes Motors	Stepper
Power Requirements	Single Phase, 230V - 5A / 110V - 10A
Frequency	50/60 Hz

Compact 1000/1000 Pro

COMPACT 3 AXIS CNC ROUTER



**QUALITY, PRECISION,
MAINTENANCE FREE
ROUTING**
For full details - See page 9

Compact 1000 Pro shown with optional universal bench and computer support extension. (PC not included)

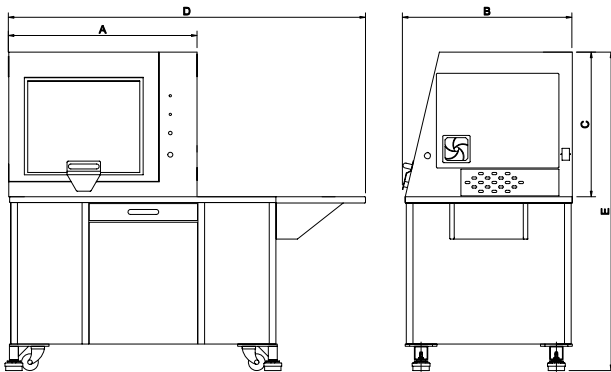

Machine Dimensions.

A compact 3 axis CNC Router with totally enclosed interlocking guard, suitable for all levels of education and training. The Compact 1000/1000 Pro is ideal for cutting a range of resistant materials such as hard and soft wood, plastic, modelling foam, acrylic and prototyping materials. In addition, the Compact 1000 Pro can cut non-ferrous metals.



APPROVED

Ideal for use in conjunction with



Compact 1000/1000 Pro

THE COMPACT 1000/1000 PRO COME AS STANDARD WITH:

- VR CNC Milling Operating Software (PC not included)
- QuickCAM 2D Design Software (1 seat)
- Aluminium T Slot Table
- Outlet for Dust Extraction System
- Workholding Clamps
- Installation and Instruction Manuals
- USB Connection

OPTIONAL EQUIPMENT INCLUDES:

Vacuum Pads, F1 in Schools Car Manufacturing Fixture, 4th Axis Programmable Rotary Fixture, 3D Scanning Attachment, Universal Machine Bench and Dust Extraction Unit.



RECOMMENDED SYSTEM REQUIREMENTS

Please refer to page 25.

RECOMMENDED SOFTWARE PROGRAMS

All software necessary to control the Compact 1000/1000 Pro is included. Also included is a seat of QuickCAM 2D Design - an easy to use 2D CAD package.

- 2D Designs: The VR Milling software can import DXF, DWG, EPS and Gerber files in addition to G & M code programs and as such will link with programs such as Techsoft 2D Design and CorelDraw.
- 3D Designs: To enable import of STL files from 3D design packages, QuickCAM Pro software is required. (see pages 38 - 39).

MECHANICAL DETAILS	COMPACT 1000	COMPACT 1000 PRO
Machine Length (A)	875mm - 34.45in	
Machine Depth (B)	765mm - 30.12in	
Machine Height (C)	675mm - 26.57in	
Length with Optional Base (D)	1678mm - 66.06in	
Height with Optional Base (E)	1440mm - 56.69in	
Machine Weight	116kg - 255.74lb	
Machine Weight with Opt. Base	230kg - 507.06lb	
Table Size	400 x 240mm - 15.75 x 9.45in	
Travel X Axis	400mm - 15.75in	
Travel Y Axis	240mm - 9.45in	
Travel Z Axis	110mm - 4.33in	
Beam Clearance	140mm - 5.51in	
Max. Spindle Speed	29000rpm	24000rpm
Non-Ferrous Metal Cutting	No	Yes
Spindle Speed Control	No	Yes
Spindle Speed Override	No	Yes
Max. Feed Rate	5000mm/min - 196.85in/min	
Max. 3D Profiling	4500mm/min - 177.17in/min	
Spindle Motor 110V Supply	800W - 1.07HP	1.0kW - 1.34HP
Spindle Motor 230V Supply	530W - 0.71HP	
Axes Motors	Stepper	
Power Requirements	Single Phase, 230V - 8A / 110V - 10A	
Frequency	50/60 Hz	

Router 2600/2600 Pro

3 AXIS CNC ROUTER

ALSO AVAILABLE:
ROUTER 2600 ATC
SEE PAGES 14-15



**QUALITY, PRECISION,
MAINTENANCE FREE
ROUTING**
For full details - See page 9

Router 2600 Pro shown with optional universal bench, computer support extension and integrated Dust Pro 100 (PC not included)

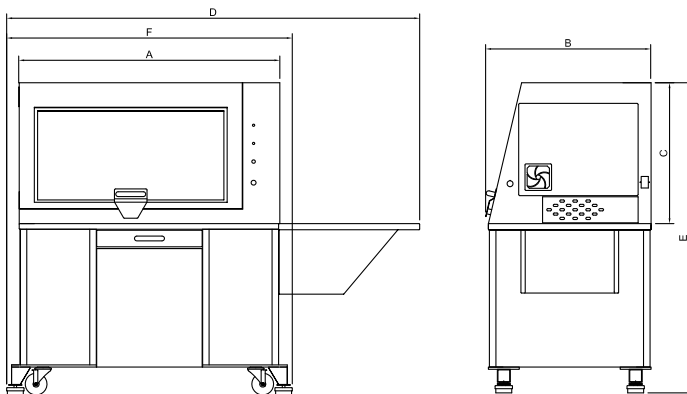

Machine Dimensions.

A 3 axis CNC Router with totally enclosed interlocking guard, suitable for all levels of education and training. With its large capacity, the Router 2600 is ideal for cutting a range of resistant materials such as hard and soft wood, plastic, modelling foam, acrylic and prototyping material. In addition, the Router 2600 Pro can cut non-ferrous metals.



Ideal for use in conjunction with



Router 2600/2600 Pro

THE ROUTER 2600/2600 PRO COME AS STANDARD WITH:

- VR CNC Milling Operating Software (PC not included)
- QuickCAM 2D Design Software (1 seat)
- Aluminium T Slot Table
- Outlet for Dust Extraction System
- Workholding Clamps
- Installation and Instruction Manuals
- USB Connection

OPTIONAL EQUIPMENT INCLUDES:

Vacuum Bed, Vacuum Pads, F1 in Schools Car Manufacturing Fixture, 4th Axis Programmable Rotary Fixture, 3D Scanning Attachment, Dust Extraction Unit and Universal Machine Bench.



RECOMMENDED SYSTEM REQUIREMENTS

Please refer to page 25.

RECOMMENDED SOFTWARE PROGRAMS

All software necessary to control the Router 2600/ Router 2600 Pro is included. Also included is a seat of QuickCAM 2D Design - an easy to use 2D CAD package.

• 2D Designs: The VR Milling software can import DXF, DWG, EPS and Gerber files in addition to G & M code programs and as such will link with programs such as Techsoft 2D Design and CorelDraw.

• 3D Designs: To enable import of STL files from 3D design packages, QuickCAM Pro software is required.

(see pages 38 - 39).

MECHANICAL DETAILS	ROUTER 2600	ROUTER 2600 PRO
Machine Length (A)	1200mm - 47.24in	
Machine Depth (B)	765mm - 30.12in	
Machine Height (C)	675mm - 26.57in	
Length with Optional PC Arm (D)	1910mm - 75.20in	
Height with Optional Base (E)	1440mm - 56.69in	
Length with Optional Base (F)	1325mm - 52.17in	
Machine Weight	150kg - 330.69lb	
Machine Weight with Opt. Base	255kg - 562.18lb	
Table Size	700 x 430mm - 27.56 x 16.93in	
Travel X Axis	600mm - 23.62in	
Travel Y Axis	400mm - 15.75in	
Travel Z Axis	110mm - 4.33in	
Beam Clearance	150mm - 5.91in	
Max. Spindle Speed	29000rpm	24000rpm
Non-Ferrous Metal Cutting	No	Yes
Spindle Speed Control	No	Yes
Spindle Speed Override	No	Yes
Max. Feed Rate	5000mm/min - 196.85in/min	
Max. 3D Profiling	4500mm/min - 177.17in/min	
Spindle Motor 110V Supply	800W - 1.07HP	1.0kW - 1.34HP
Spindle Motor 230V Supply	1.0kW - 1.34HP	1.34HP
Axes Motors	Stepper	
Power Requirements	Single Phase, 230V - 8A / 110V - 10A	
Frequency	50/60 Hz	

Router 2600 ATC & Router 6600 ATC

3 AXIS CNC ROUTERS WITH 5 STATION ATC



5 Station Automatic Tool Changer

**QUALITY, PRECISION,
MAINTENANCE FREE
ROUTING**

For full details - See page 9

Router 2600 ATC shown with optional universal bench, computer support extension and integrated Dust Pro 100 (PC not included)

For Router 2600 ATC Machine Dimensional Drawings

See page 12.

For Router 6600 ATC Machine Dimensional Drawings

See page 16.

These 3 axis CNC Routers with totally enclosed interlocking guard and complete with 5 Station Automatic Tool Changer are suitable for all levels of education and are ideal for cutting a range of resistant materials such as hard and soft wood, plastic, modelling foam, acrylic, prototyping material and non-ferrous metals.

Additionally, the Router 6600 ATC is a high speed machine, complete with built-in machine bench, offering large machining capacity (table size 1080 x 640mm) at an exceptional price.



APPROVED

Ideal for use in conjunction with



Router 2600 ATC & Router 6600 ATC

THE ROUTER 2600 ATC & ROUTER 6600 ATC COME AS STANDARD WITH:

- VR CNC Milling Operating Software (PC not included)
- QuickCAM 2D Design Software (1 seat)
- 5 Station Automatic Tool Changer (5 SK11 Toolholders and 8 Collets)
Requires compressed air, 8 bar
- Aluminium T Slot Table
- Outlet for Dust Extraction System
- Workholding Clamps
- Installation and Instruction Manuals
- USB Connection

In addition, the Router 6600 ATC comes complete with Universal Machine Bench.

OPTIONAL EQUIPMENT INCLUDES:

Vacuum Bed, Vacuum Pads, F1 in Schools Car Manufacturing Fixture, 4th Axis Programmable Rotary Fixture, 3D Scanning Attachment, Dust Extraction Unit and Universal Machine Bench (Router 2600 ATC).



RECOMMENDED SYSTEM REQUIREMENTS

Please refer to page 25.

RECOMMENDED SOFTWARE PROGRAMS

All software necessary to control the Router 2600 ATC & Router 6600 ATC is included. Also included is a seat of QuickCAM 2D Design - an easy to use 2D CAD package.

- 2D Designs: The VR Milling software can import DXF, DWG, EPS and Gerber files in addition to G & M code programs and as such will link with programs such as Techsoft 2D Design and CorelDraw.
- 3D Designs: To enable import of STL files from 3D design packages, QuickCAM Pro software is required. (see pages 38 - 39).

MECHANICAL DETAILS	ROUTER 2600 ATC	ROUTER 6600 ATC
Machine Length (A)	1200mm	1825mm
Machine Depth (B)	765mm	985mm
Machine Height (C)	675mm	1540mm
Length with Optional PC Arm (D)	1910mm	2410mm
Height with Optional Base (E)	1440mm	-
Height with Door Open (E)	-	2110mm
Length with Optional Base (F)	1325mm	-
Machine Weight	150kg	430kg
Machine Weight with Opt. Base	255kg	-
Table Size	700 x 430mm	1080x 640mm
Travel X Axis	600mm	1000mm
Travel Y Axis	400mm	600mm
Travel Z Axis	110mm	110mm
Beam Clearance	150mm	148mm
Max. Spindle Speed	24000rpm	
Non-Ferrous Metal Cutting	Yes	
Spindle Speed Control	Yes	
Spindle Speed Override	Yes	
Max. Feed Rate	5000mm/min	
Max. 3D Profiling	4500mm/min	
Spindle Motor	0.9kW - 1.21HP	
Axes Motors	Stepper	
Power Requirements	Single Phase, 230V - 8A / 110V - 10A	
Frequency	50/60 Hz	

For Imperial measurements please refer to Router 2600 Pro on page 13 and Router 6600 Pro on page 17.

Router 6600/6600 Pro

LARGE FORMAT, HIGH SPEED FLOOR-STANDING ROUTER

ALSO AVAILABLE:
ROUTER 6600 ATC
SEE PAGES 14-15



QUALITY, PRECISION,
MAINTENANCE FREE
ROUTING

For full details - See page 9

Router 6600 shown with optional computer support extension and integrated Dust Pro 100 (PC not included)

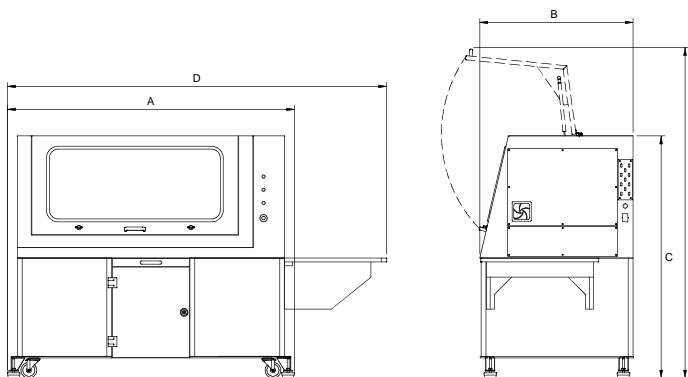

Machine Dimensions.

A large format, high speed Router, complete with built-in machine bench, offering large machining capacity (table size 1080 x 640mm) at an exceptional price. The Router 6600 / 6600 Pro is specifically designed for education and training and is ideal for cutting a range of resistant materials such as hard and soft wood, plastic, modelling foam, acrylic and prototyping material. In addition, the Router 6600 Pro can cut non-ferrous metals.



APPROVED

Ideal for use in conjunction with



Router 6600/6600 Pro

THE ROUTER 6600/6600 PRO COME AS STANDARD WITH:

- VR CNC Milling Operating Software (PC not included)
- QuickCAM 2D Design Software (1 seat)
- Universal Machine Bench
- Aluminium T Slot Table
- Outlet for Dust Extraction System
- Workholding Clamps
- Installation and Instruction Manuals
- USB Connection

OPTIONAL EQUIPMENT INCLUDES:

Large Format Vacuum Bed, Vacuum Pads, F1 in Schools Car Manufacturing Fixture, 4th Axis Programmable Rotary Fixture, 3D Scanning Attachment, Dust Extraction Unit, Computer Support Extension.



RECOMMENDED SYSTEM REQUIREMENTS

Please refer to page 25.

RECOMMENDED SOFTWARE PROGRAMS

All software necessary to control the Router 6600/ Router 6600 Pro is included. Also included is a seat of QuickCAM 2D Design - an easy to use 2D CAD package.

• 2D Designs: The VR Milling software can import DXF, DWG, EPS and Gerber files in addition to G & M code programs and as such will link with programs such as Techsoft 2D Design and CorelDraw.

• 3D Designs: To enable import of STL files from 3D design packages, QuickCAM Pro software is required (see pages 38 - 39).

MECHANICAL DETAILS	ROUTER 6600	ROUTER 6600 PRO
Machine Length (A)	1825mm - 71.85in	
Machine Depth (B)	985mm - 38.78in	
Machine Height (C)	1540mm - 60.63in	
Length with Optional PC Arm (D)	2410mm - 94.88in	
Height with Door Open (E)	2110mm - 83.07in	
Machine Weight	430kg - 947.99lb	
Table Size	1080 x 640mm - 42.52 x 25.20in	
Travel X Axis	1000mm - 39.37in	
Travel Y Axis	600mm - 23.62in	
Travel Z Axis	110mm - 4.33in	
Beam Clearance	148mm - 5.83in	
Max. Spindle Speed	29000 rpm	24000 rpm
Non-Ferrous Metal Cutting	No	Yes
Spindle Speed Control	No	Yes
Spindle Speed Override	No	Yes
Max. Feed Rate	5000mm/min - 196.85in/min	
Max. 3D Profiling	4500mm/min - 177.17in/min	
Spindle Motor 110V Supply	800W - 1.07HP	1.0kW - 1.34HP
Spindle Motor 230V Supply	1.0kW - 1.34HP	
Axes Motors	Stepper	
Power Requirements	Single Phase, 230V - 8A / 110V - 10A	
Frequency	50/60 Hz	

Router Accessories

FLOATING HEAD, SELF CENTRING VICE, VACUUM BEDS, CLAMPING KITS, FIXTURES AND DUST EXTRACTION UNITS

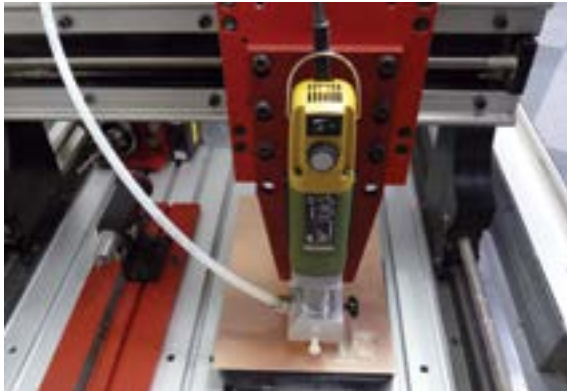

PCB PRODUCTION WITH A FLOATING HEAD

Denford's 'Floating Head' option permits manufacture of PCB's and engraving of uneven surfaces, and is ideal for batch manufacture of PCB boards.

The floating head comes complete with a quick change facility for a swift interchange with the standard issue router motor.

The cutting tool profiles around the outside of the tracks creating an isolation gap. The weight of the spindle motor plunges the cutter into the PCB board, and depth is set by a plastic disc that floats on the material surface. A float up to 5mm is possible using this technology.



SELF CENTRING VICE

140 x 345mm flat precision vice with low physical height offering a maximum clamping width of 222mm.

Supplied with mountings for Denford Router T-Slot tables and additional V-type steel vice jaws for holding round work-pieces.



DUST PRO 100 EXTRACTION UNIT

Denford's large capacity dust extraction system is a purpose-designed dust control system for use with the Compact 1000/Pro, Router 2600/Pro/ATC & Router 6600/Pro/ATC. It can be used as a stand-alone unit, or incorporated within Denford's universal machine bench, as shown above.

The unit is highly effective in removing airborne dust and light particles produced during machining, and is recommended for schools where MDF is regularly used. The unit comes ready to use including a removable / re-usable dust collection bag and separate HEPA filter.

Dimensions: H530mm W460mm D670mm
H20.87in W18.11in D26.38in



DUST PRO 50 EXTRACTION UNIT

Particle and dust extraction unit suitable for use with the Compact 1000/Pro and Router 2600/Pro/ATC. This purpose designed unit is ideal for extraction of airborne dust created during the manufacturing process, and also to vacuum the machine after the cutting process is complete.

The unit comes complete with castors, flexible hose and fittings.

Dimensions: H530mm W300mm D300mm
H20.87in W11.81in D11.81in



F1 IN SCHOOLS CAR FIXTURE

The F1 in Schools Car Manufacturing Fixture to enable the manufacture of Formula 1 Class cars. The fixture clamps directly to the T-Slot table on the Compact 1000/Pro, Router 2600/Pro/ATC and Router 6600/Pro/ATC. It is also suitable for use on the VMC 1300.



ADDITIONAL CLAMPING KIT

Additional Clamping Kit includes 2 parallel clamping rails with T-nuts, (allowing the workpiece to be raised from the bed, to permit 'through' machining), 1 additional L bracket and lever clamp with T-nuts.



LARGE FORMAT VACUUM BED

Suitable for use with the Router 2600/Pro/ATC and Router 6600/Pro/ATC, the large format bed is supplied with an external vacuum pump. Suitable for 'blind' machining and 'through' machining when used with sacrificial mat.

It is available in 2 sizes:

- 600 x 400mm - 23.62 x 15.75in: Router 2600/Pro/ATC, Router 6600/Pro/ATC.
- 1000 x 600mm - 39.37 x 23.62in: Router 6600/Pro/ATC (as shown above).

Requires single phase, 16A supply protected by either a fuse or an MCB C Type.



VACUUM PADS

Vacuum Pads are suitable for the Compact 1000/Pro, Router 2600/Pro/ATC and Router 6600/Pro/ATC. The package includes 2 vacuum pads and an integral vacuum pump.

Suitable for 'blind' machining only.



EasySCAN 3D Scanner

3D SCANNING ATTACHMENT & SOFTWARE FOR DENFORD ROUTERS



1. Select and scan the model

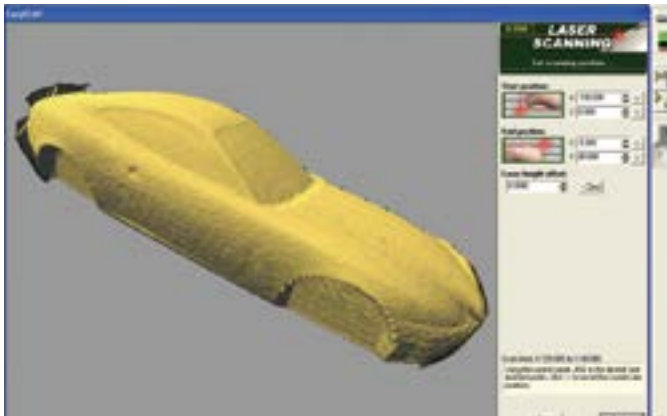

2. Manipulate scan data



3. Manufacture on a Denford CNC Router



4. Completed model

Denford's EasySCAN 3D Scanner attachment has full 360 degree scanning capability when used in conjunction with Denford's Rotary Fixture, and is suitable for use with the entire range of Denford CNC Routers.

The EasySCAN 3D package incorporates user friendly, wizard based software for scanning, editing and saving 3D models, prior to manufacture on a Denford CNC Router.

EasySCAN 3D is ideal for Reverse Engineering applications.



4th Axis Programmable Rotary Fixture

COMPLETE WITH QUICKCAM 4D MILLING SOFTWARE

4TH AXIS PROGRAMMABLE ROTARY FIXTURE



for use with
Compact 1000/Pro
Router 2600/Pro/ATC
Router 6600/Pro/ATC
(also available for
VMC1300/Pro with the
exception of flood coolant models).

QUICKCAM 4D MILLING SOFTWARE

(Supplied FREE with the Denford 4th Axis Programmable Rotary Fixture.)

An easy to use, wizard based CAM package specifically designed for use with the Denford 4th Axis Programmable Rotary Fixture. QuickCAM 4D Milling imports 3D files from most 3D CAD packages and converts these into 4th axis CNC program data for output to the range of Denford CNC Routers. Users are guided through a series of simple steps, defining billet size, model orientation, machining strategy and axis of rotation before generating the appropriate CNC output file.

QUICKCAM 4D MILLING FEATURES

True 3 Dimensional model-making capabilities. Seamless integration with VR CNC Milling software. Circular, spiral and linear machining strategies. User definable limits allow for workholding avoidance. Supports both roughing and finishing paths. Resize, orientate and centre the model. Autoscale of model to fit the workpiece.

SUPPORTED OUTPUT FORMATS

CNC controllers for Denford CNC Routers.

SUPPORTED INPUT FORMATS

3D Stereo Lithography (STL) files,
as created with 3D design packages.

RECOMMENDED SYSTEM REQUIREMENTS

1 GHz Processor,
1 GB Memory,
32 GB Hard Disk,
Microsoft Windows 7, 8 & 10,
OpenGL Graphics Card, or built in Graphics,
to support a minimum 1024 x 768 Screen Resolution,
CNC machines require USB Connection.
EasySCAN requires 1 USB Connection

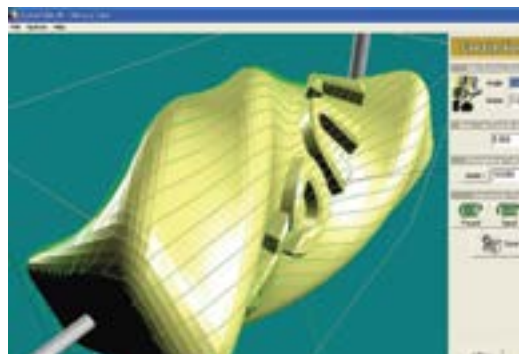

VMC 1300/1300 Pro

CNC MILLING MACHINE



AVAILABLE WITH:

- Flood Coolant & Industrial Cabinet Base
- 6 or 8 Station Automatic Tool Changer
- Automatic Lubrication System

VMC 1300 Pro shown with optional universal bench and computer support extension. (PC not included)

A 3 axis CNC milling machine available either floor standing or for bench mounting, with totally enclosed high visibility interlocking guard, suitable for all levels of education and training. Programmable spindle speeds and feedrates make the VMC 1300 ideal for cutting a range of resistant materials such as wax, plastic, acrylic, free cutting alloys, aluminium and steel. The VMC 1300 Pro has a more powerful, higher speed spindle (6000 rpm) for heavy duty cutting. Now available with 6 or 8 Station Automatic Tool Changer and the option of Flood Coolant with Industrial Cabinet Base.

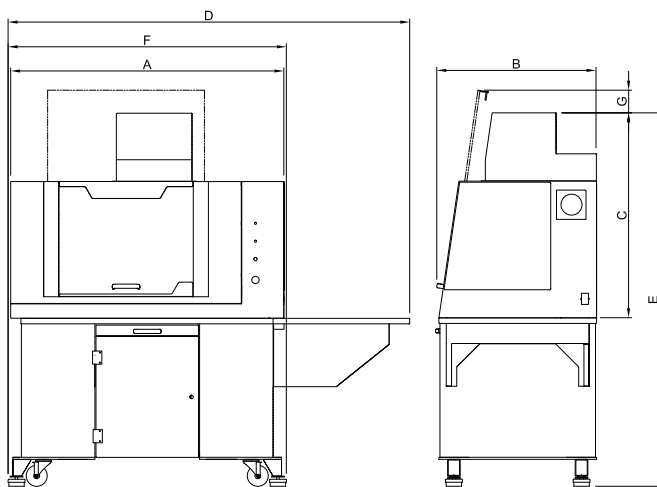

Machine Dimensions.



VMC 1300/1300 Pro

THE VMC 1300/1300 PRO COME AS STANDARD WITH:

- VR CNC Milling Operating Software (PC not included)
- QuickCAM 2D Design Software (1 seat)
- Power Drawbar with Manual Actuation
- Workholding Clamps
- Installation and Instruction Manuals
- USB Connection

NB The Flood Coolant model comes complete with Industrial Cabinet Base.

OPTIONAL EQUIPMENT INCLUDES:

Table Mounted 6 or 8 Station Automatic Tool Changer (which can be removed to enable full 375mm X axis travel), Pneumatic Vice and Guard, Spray Mist Coolant, Automatic Lubrication System, 4th Axis Programmable Rotary Fixture (not available with flood coolant model) and Universal Machine Bench (flood coolant model comes as standard with industrial cabinet base).



RECOMMENDED SYSTEM REQUIREMENTS

Please refer to page 25.

RECOMMENDED SOFTWARE PROGRAMS

All software necessary to control the VMC 1300/1300 Pro is included. Also included is a seat of QuickCAM 2D Design - an easy to use 2D CAD package.

• 2D Designs: The VR Milling software can import DXF, DWG, EPS and Gerber files in addition to G & M code programs and as such will link with programs such as Techsoft 2D Design and CorelDraw.

• 3D Designs: To enable import of STL files from 3D design packages, QuickCAM Pro software is required. (see pages 38 - 39).

MECHANICAL DETAILS	VMC 1300	VMC 1300 PRO
Machine Length (A)	1300mm - 51.18in	
Machine Depth (B)	750mm - 29.53in	
Machine Height (C)	1325mm - 52.17in	
Length with Optional PC Arm (D)	1910mm - 75.20in	
Machine Height with Optional Base (E)	1765mm - 69.49in	
Machine Length with Optional Base (F)	1330mm - 52.36in	
Additional Height door open (G)	65mm - 2.56in	
Machine Weight	353kg - 778.23lb	
Machine Weight with Opt. Base	456kg - 1005.31lb	
Table Size	600 x 180mm - 23.62 x 7.09in	
Travel X Axis Without ATC	375mm - 14.76in	
Travel X Axis With ATC Fitted	250mm - 9.84in	
Travel Y Axis	160mm - 6.30in	
Travel Z Axis	235mm - 9.25in	
Table to Spindle	305mm - 12.01in	
Max. Spindle Speed	4000rpm	6000rpm
Max. Feed Rate	5000mm/min - 196.85in/min	
Max. 3D Profiling	4500mm/min - 177.17in/min	
Spindle Motor	1.1kW - 1.48HP	1.6kW - 2.15HP
Axes Motors	Stepper	
Power Requirements	Single Phase, 230V - 10A / 110V - 16A	
Frequency	50/60 Hz	

Turn 270 Pro

CNC LATHE



Turn 270 Pro shown with optional universal bench and computer support extension. (PC not included)

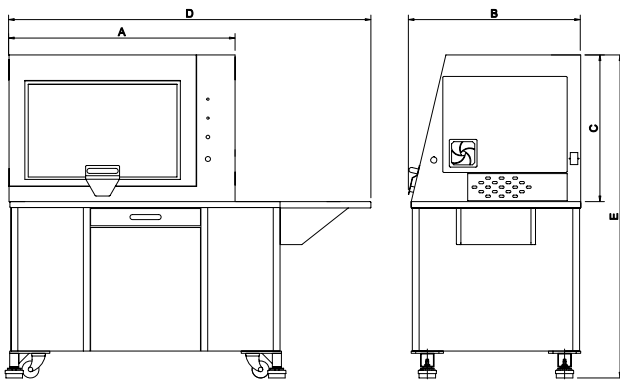

Machine Dimensions.

A compact 2 axis CNC Lathe with totally enclosed high-visibility interlocking guard, suitable for all levels of education and training. Programmable spindle speeds and feedrates make the Turn 270 Pro ideal for cutting a range of resistant materials such as wax, plastic, acrylic, free cutting alloys, aluminum and steel.



Turn 270 Pro

THE TURN 270 PRO COMES AS STANDARD WITH:

- VR CNC Turning Operating Software (PC not included)
- QuickTURN 2D Design Software (1 seat)
- Quick Change Toolpost and Holder
- Manual Self Centring 100mm 3 Jaw Chuck
- Installation and Instruction Manuals
- USB Connection

OPTIONAL EQUIPMENT INCLUDES:

Comprehensive Tooling Package, 8 Station Programmable Turret, Pneumatic Chuck and Guard, Spray Mist Coolant, Automatic Lubrication System, Tail Stock, and Universal Machine Bench.



RECOMMENDED SYSTEM REQUIREMENTS

- 1 GHz Processor,
- 1 GB Memory,
- 32 GB Hard Disk,
- Microsoft Windows 7, 8 & 10,
- OpenGL Graphics Card, or built in Graphics, to support a minimum 1024 x 768 Screen Resolution, CNC machines require USB Connection.

RECOMMENDED SOFTWARE PROGRAMS

All software necessary to control the Turn 270 Pro is included. Also included is a seat of QuickTURN 2D Design - an easy to use CAD package.

MECHANICAL DETAILS	TURN 270 PRO
Machine Length (A)	1000mm - 39.37in
Machine Depth (B)	768mm - 30.24in
Machine Height Bench Mounting (C)	675mm - 26.57in
Length with Optional Base (D)	1665mm - 65.55in
Height with Optional Base (E)	1440mm - 56.69in
Machine Weight	140kg - 308.65lb
Machine Weight with Optional Base	255kg - 562.18lb
Swing Over Bed	190mm - 7.48in
Swing Over Cross Slide	100mm - 3.94in
Distance Between Centres	270mm - 10.63in
Travel X Axis	150mm - 5.91in
Travel Z Axis	225mm - 8.86in
Max. Spindle Speed	4000rpm
Max. Feed Rate	3000mm/min - 118.11in/min
Spindle Bore	26mm - 1.02in
Spindle Motor	1.5kW - 2.01HP
Axes Motors	Stepper
Power Requirements	Single Phase, 230V - 8A / 110V - 10A
Frequency	50/60 Hz

Turn 370 Pro

HIGH CAPACITY CNC LATHE



COMPLETE WITH
FLOOD COOLANT
AND INDUSTRIAL
CABINET BASE

Turn 370 Pro shown
with optional computer support extension
(PC not included)

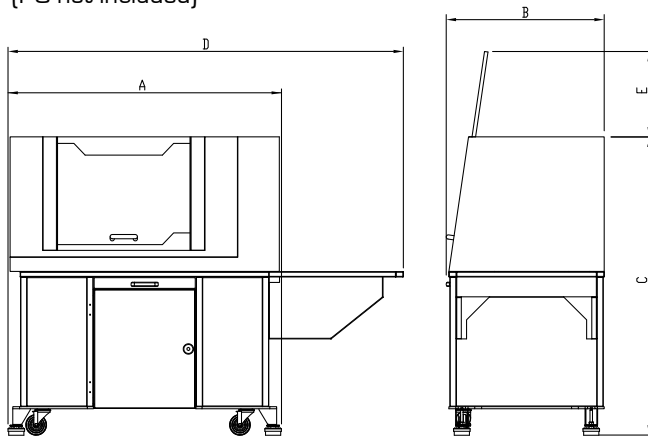

Machine Dimensions.

A high capacity 2 axis CNC Lathe complete with flood coolant and industrial cabinet base and totally enclosed high-visibility interlocking guard, suitable for all levels of education and training. Programmable spindle speeds and feedrates make the Turn 370 Pro ideal for cutting a range of resistant materials such as wax, plastic, acrylic, free cutting alloys, aluminum and steel.



Turn 370 Pro

THE TURN 370 PRO COMES

AS STANDARD WITH:

- VR CNC Turning Operating Software (PC not included)
- QuickTURN 2D Design Software (1 seat)
- Flood Coolant and Industrial Cabinet Base
- Quick Change Toolpost and Holder
- Manual Self Centring 125mm 3 Jaw Chuck
- Installation and Instruction Manuals
- USB Connection

OPTIONAL EQUIPMENT INCLUDES:

8 Station Programmable Turret (supplied in lieu of Quick Change Toolpost), Pneumatic Chuck and Guard, Tail Stock and Automatic Lubrication System.



RECOMMENDED SYSTEM REQUIREMENTS

1 GHz Processor,
1 GB Memory,
32 GB Hard Disk,
Microsoft Windows 7, 8 & 10,
OpenGL Graphics Card, or built in Graphics,
to support a minimum 1024 x 768 Screen Resolution,
CNC machines require USB Connection.

RECOMMENDED SOFTWARE PROGRAMS

All software necessary to control the Turn 370 Pro is included. Also included is a seat of QuickTURN 2D Design - an easy to use CAD package.

MECHANICAL DETAILS	TURN 370 PRO
Machine Length (A)	1330mm - 52.36in
Machine Depth (B)	750mm - 29.53in
Machine Height (C)	1445mm - 56.89in
Length with Optional PC Arm (D)	1910mm - 75.20in
Open Door Height Above Machine (E)	385mm - 15.16in
Machine Weight	400kg - 881.85lb
Swing Over Bed	260mm - 10.24in
Swing Over Cross Slide	105mm - 4.13in
Distance Between Centres	370mm - 14.57in
Travel X Axis	200mm - 7.87in
Travel Z Axis	275mm - 10.83in
Max. Spindle Speed	3700rpm
Max. Feed Rate	3000mm/min - 118.11in/min
Spindle Bore	35mm - 1.38in
Spindle Motor	2.2kW - 2.95HP
Axes Motors	Stepper
Power Requirements	Single Phase, 230V - 10A / 110V - 16A
Frequency	50/60Hz
Electrical Socket	16A MCB Protected

Micromill

CNC MILLING MACHINE

Microturn

CNC LATHE



THE MICROMILL COMES AS STANDARD WITH:

- VR CNC Milling Operating Software (PC not included)
- QuickCAM 2D Design Software
- Workholding Clamps
- 3 x 6mm Dia Toolholders
- 2mm, 4mm & 6mm Dia Slot Drills
- Set of Imperial / Metric Allen Keys
- Maintenance Tools
- Installation and Instruction Manuals

A compact 3 axis CNC milling machine and 2 axis CNC lathe, both with totally enclosed interlocking guards – the ideal introduction to CNC manufacturing. Variable spindle speeds and feedrates make the Micromill and Microturn suitable for proving student designs, producing small components in materials such as wax, plastic, acrylic and free cutting alloys.



THE MICROTURN COMES AS STANDARD WITH:

- VR CNC Turning Operating Software (PC not included)
- QuickTURN 2D Design Software
- Quick Change Toolpost & Holders
- LH and RH Cutting Tools
- Parting Off Tool
- 2 ½" Dia 3 Jaw Chuck & 2 Tommy Bars
- 1 ½" Standard Toolpost
- Tailstock
- Set of Imperial / Metric Allen Keys
- Maintenance Tools
- Installation and Instruction Manuals

OPTIONAL EQUIPMENT INCLUDES:

MICROMILL

Milling Vice

MICROTURN

Thread Cutting Package

NEW

Denford Duo

INTRODUCTORY CNC MILLING & TURNING PACKAGE

Shown with optional universal bench and 2 x computer support extensions (PC's not included)



A combined entry-level CNC Milling and Turning Package (available at a special package price), incorporating the Micromill CNC Milling machine and CNC Microturn Lathe, complete with tooling and software – the ideal introduction to CNC manufacturing. See page 28 for details of machines, standard and optional equipment.

OPTIONAL UPGRADE:

Universal Machine Bench, complete with 2 Computer Support Extensions (see above image)
 Bench Size with Computer Support Extensions:
 2500mm x 750mm x 790mm (WxDxH)



SYSTEM REQUIREMENTS

For Micromill/Microturn/Denford Duo please refer to page 25.

MECHANICAL DETAILS	MICROMILL	MICROTURN
Machine Length (A)	685mm - 26.97in	685mm - 26.97in
Machine Depth (B)	654mm - 25.75in	654mm - 25.75in
Machine Height (C)	688mm - 27.09in	688mm - 27.09in
Machine Weight	50kg - 110lbs	57kg - 125lbs
Table Size	70x330mm 2.76x12.99in	n/a
Swing Over Bed	n/a	90mm - 3.5in
Travel X Axis	228mm - 8.98in	50mm - 1.97in
Travel Y Axis	130mm - 5.12in	n/a
Travel Z Axis	160mm - 6.30in	126mm - 4.96in
Table to Spindle	182mm - 7.17in	n/a
Max. Spindle Speed	2500rpm	2500rpm
Max. Feed Rate	600mm/min 23.62in/min	600mm/min 23.62in/min
Max. 3D Profiling	600mm/min 23.62in/min	n/a
Spindle Motor	75W - 0.1HP	
Axes Motors	Stepper	
Power Requirements	Single Phase, 230V - 8A / 110V - 10A	
Frequency	50/60Hz	

Universal Machine Benches



**Universal Machine Bench
VMC/0600B**
(For Router 2600/Pro, Router 2600 ATC,
VMC1300/Pro)

Shown with optional computer
support extension.
(PC not included)



Universal Machine Bench VMC/0600WB
(Stand alone bench)

Denford's Universal Machine Benches are suitable for use with our entire range of CNC Routers, Mills and Lathes. The benches are designed to accommodate varying requirements, and to integrate with existing furniture in a traditional workshop environment, or an IT suite.



Universal Machine Benches

The Universal Machine Bench comes with wheels, anti-vibration pads, storage cupboard, tooling drawer and is suitable for a range of bench top machines including:-

VMC 1300/Pro, Router 2600/Pro/ATC

Optional - Computer Support Extension

Optional - Integrated Dust Pro 100

Product Code: VMC/0600B

Product Code: VMC/0602

Product Code: ADVXU

Compact 1000/Pro

Includes - Computer Support Extension

Optional - Integrated Dust Pro 100

Product Code: MRCWB

Product Code: ADVXU

Turn 270 Pro

Includes - Computer Support Extension

Product Code: TRNWB

Denford Duo

Includes - 2 Computer Support Extensions

Product Code: VMC/0600WBM

Stand-Alone Workbench

Optional - Computer Support Extension

Optional - Integrated Dust Pro 100

Product Code: VMC/0600WB

Product Code: VMC/0602

Product Code: ADVXU

Bench Size: 1330mm x 750mm x 790mm (WxDxH) 52.36in x 29.53in x 31.10in

Colour: Grey

Weight: 103kg - 227.08lbs (with integrated dust extraction unit 163kg - 359.35lbs)



Universal Machine Bench VMC/0600WB

Shown with integrated Dust Pro 100.

Machine Refurbishment

REFURBISHMENT AND RE-WARRANTY PACKAGE

Let Denford Refurbish your Machine and Return it complete with Warranty Package!



NOVAMILL ATC BEFORE



NOVAMILL ATC AFTER



Denford's State-of-the-Art Workshops



Upgrade to Latest CNC Technology

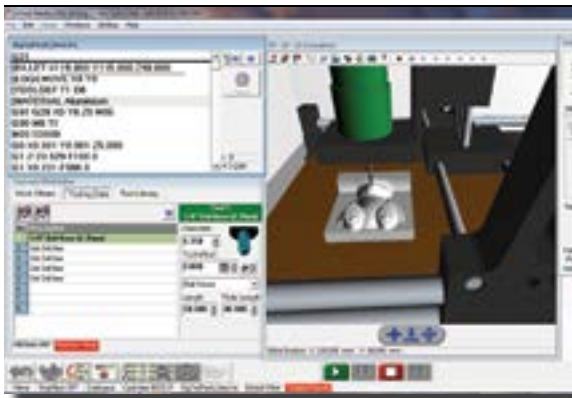

Latest VR CNC Machine Control Software



Training at Denford and Warranty Package



Machine Refurbishment

The Denford Refurbishment & Re-Warranty Package provides a complete refurbishment, complete with warranty, for your existing Denford machine(s) and offers huge savings on the cost of a new machine.

THE REFURBISHMENT PACKAGE INCLUDES:

- Mechanical/electrical service/inspection.
- Replacement of serviceable items, where necessary.
- Replacement of guards/side windows and new labels fitted.
- Upgrade to Nextmove technology with USB connectivity, where applicable.
- Supply of latest versions of VR Milling V5 and QuickCAM 2D Design for Routers and Novamill.
- Supply of latest versions of VR Turning and QuickTURN 2D Design for Novaturn.
- One day training course at Denford for 2 people. (Does not include travel costs or local expenses)
- Machines will be cleaned (not repainted).
- Novaturns and Novamills will be fitted into new cabinets with integral electronics.
- 3 year on-site parts & labour Warranty (UK).
- 1 year parts only Warranty (Overseas).

Subject to inspection and approval, we are able to refurbish the following Denford machines:



**Microrouter
Compact**



**Microrouter
V3 & V4 / Pro**



**Compact
1000 / Pro**



**Router
2600 / Pro**



Novaturn

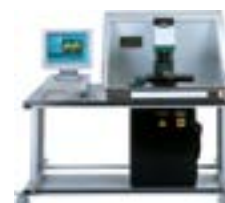

Novamill / ATC

PACKAGE DETAILS	PRODUCT CODE
Microrouter Compact Refurbishment & Warranty	RWP0001
Microrouter V3 & V4 / Pro Refurbishment & Warranty	RWP0002
Compact 1000 Refurbishment & Warranty	RWP0003
Compact 1000 Pro Refurbishment & Warranty	RWP0004
Router 2600 Refurbishment & Warranty	RWP0005
Router 2600 Pro Refurbishment & Warranty	RWP0006
Novaturn Refurbishment & Warranty	RWP0007
Novamill / ATC Refurbishment & Warranty	RWP0008

Refurbishments will take place at Denford Limited and will be subject to packing and freight charges. Benches shown above are no longer available and are shown for illustration purposes only.

LaserCAM 2D Design

2D DESIGN SOFTWARE FOR LASER CUTTERS

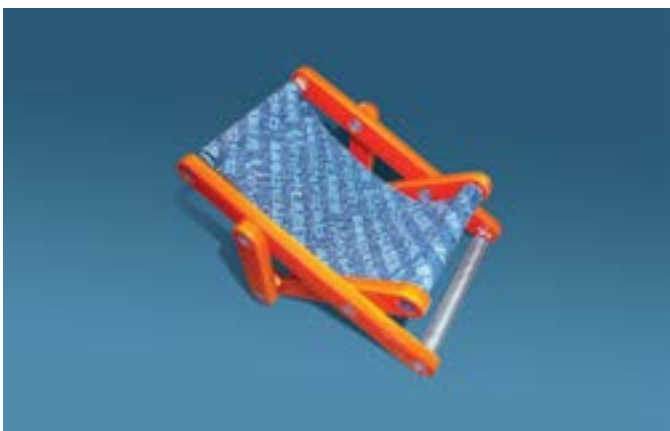
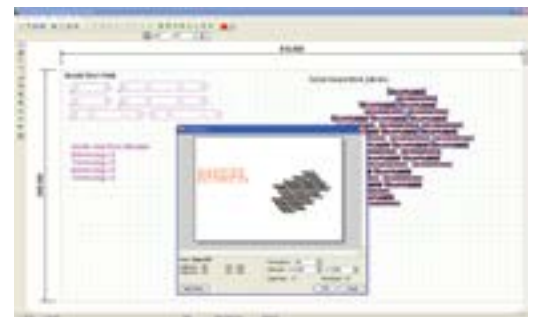
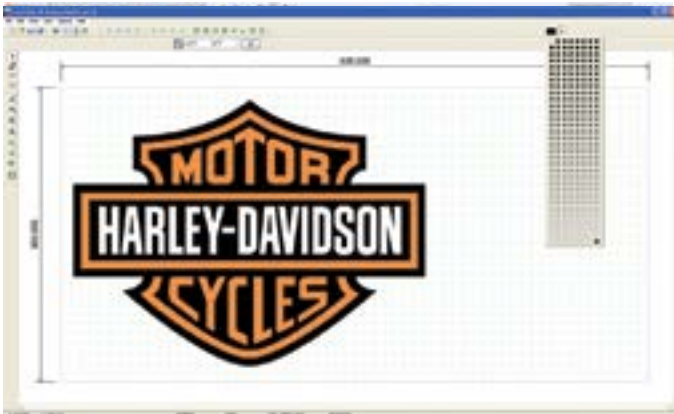

LaserCAM 2D is a 2D CAD solution for use with Laser cutting machines. Simple designs can be created quickly and accurately and output to a laser with minimum effort. A host of import options make it the ideal way to manufacture logos, designs and projects on most types of Laser cutter & engraver.

LaserCAM 2D Design

POWERFUL TOOLS TO MAKE LASER MANUFACTURING EASY

LaserCAM 2D Design has all the features you need for laser cutting / engraving - all in one place. For example, the image importer includes image editing features to adjust brightness, contrast and gamma. The interactive preview and tools to create greyscale, black and white or halftone images will ensure you get the best results every time.

Custom colour palettes make it easy to pick the right colours for the laser driver (e.g. solid blue for vector engraving, solid red for vector cutting, black for raster engraving).

Grid size setup is easy - just click 'Match to Printer' and select the laser driver you're going to use.

Before printing your design, the handy preview window allows you to offset its position and scale, without altering the original. It also gives you the option to only output selected objects.

With a wealth of designs available in postscript (.EPS) and metafile (.WMF, .EMF) formats, you will never be stuck for logos or cool designs!

CAD DRAWING FEATURES

The following objects can be created to exact sizes:

Lines, Arcs, Polylines, Curves, Polygons, Ellipses, Text*, Multi-line Text with justification*, Hatched areas, Offset paths, Bitmap Image Contours.

*Any TrueType font available to Windows™ can be installed and used by LaserCAM

Drawing features allow easy creation and manipulation of objects:

Customisable grid size for snapping to fixed distances, Editable object nudge, Angular (polar) snap, Absolute and relative co-ordinate entry, Object property editor allows sizes, angles and positions to be entered exactly, Quick drawing navigation (pan & zoom) is realised by

mouse wheel operation, Object grips can be grabbed and moved, Various object snap modes can be activated at any time: End point; Mid point; Nearest; Intersection; Tangent; Perpendicular Object modifiers allow objects to be altered quickly and accurately: Move, Scale, Rotate, Mirror, Copy, Paste, Join, Explode, Group and Ungroup, Customisable colour palettes for easy configuration to match the Laser driver, Rectangular array, Circular array, Boolean shape operators: Union; Intersect; Split; Subtract.

IMPORT/EXPORT FEATURES

Import:

- Raster Images: .JPG; .BMP; .ICO; .EMF; .WMF
- Clipboard paste from other drawing packages such as CorelDraw.
- PCB Gerber file (RS274X).
- AutoCAD: .DWG and .DXF (versions up to 2000).
- Vector image clipart metafiles: .WMF and .EMF
- Fonts: True type .TTF font files.
- Encapsulated PostScript: .EPS vector files.

Export:

- AutoCAD: .DXF files can be saved.
- QuickCAM 2D Design: .MCM files saved in LaserCAM can also be opened in QuickCAM 2D for CNC machining.

RECOMMENDED SYSTEM REQUIREMENTS

1 GHz Processor,
1 GB Memory,
32 GB Hard Disk,
Microsoft Windows 7, 8 & 10,
OpenGL Graphics Card, or built in Graphics,
to support a minimum 1024 x 768 Screen Resolution,
CNC machines require USB Connection.

QuickCAM 2D Design

2D DESIGN & MANUFACTURE SOFTWARE

INCLUDES ADVANCED
V-CARVE EXTENSION

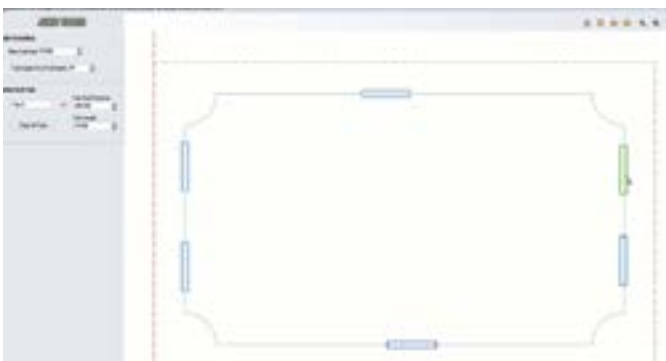
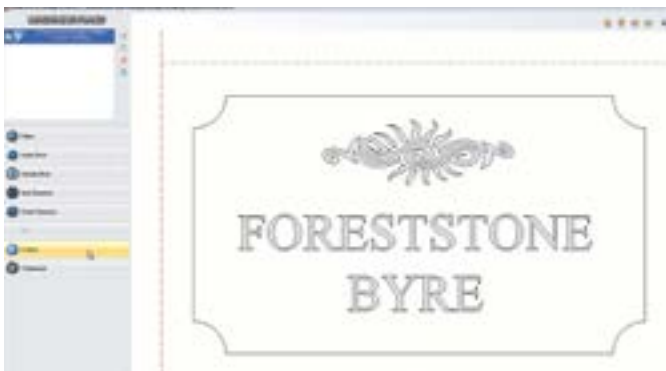

QuickCAM 2D Design is an advanced, yet simple to use, wizard based 2D CAD/CAM package. You can create designs quickly and accurately, then run the CAM wizard to create CNC machine toolpaths. It features various import options to allow images, PCB's and designs from other CAD packages to be manufactured. The customisable post processor and advanced printing facilities provide outputs to most desktop CNC and laser machines.

QuickCAM 2D Design

CAD DRAWING FEATURES

Shape Creation:

Line, Polyline, Rectangle, Curve/Spline, Circle, Arc, Point, Polygon, Ellipse, Text, Multiple Line Text with Justification, Hatch, Offset Path, Image Outline (Contrast Edge Detection).

Drawing Help:

Customisable Grid Size, Grid Snap, Object Nudge, Polar Snap, Absolute and Relative Co-ordinate Entry, Shape Property Editors, Fast Drawing Navigation.

Snap Modes: End, Middle, Nearest, Intersection, Tangent.

Shape Modification:

Unlimited Undo and Redo, Move, Scale, Rotate, Mirror, Copy, Paste, Join, Explode, Group and Ungroup multiple shapes, Apply colour to any shape, Modify shape using grips or by property editor, Boolean shape operations: Union, Intersect, Split, Subtract, Rectangular Repeat, Circular Repeat.

Automatic Island Recognition:

Selects whether shapes within shapes are machined on the inside or the outside.

Each island's level (ie, inside or outside) can be altered manually.

IMPORT/EXPORT FEATURES

Import

- Raster Image - JPG,BMP,ICO,EMF,WMF.
- Clipboard Vector paste (eg from CorelDraw)
- Gerber (RS274X) - PCB designs are imported and converted into polylines.
- Autocad drawings (DWG,DXF) - drawings can be imported (Autocad versions 2.5 through to 2000).
- Vector Image Clipart - WMF, EMF.
- Font - any Truetype Font (TTF) can be imported then used by the software.

Export

- Autocad DXF versions 10 through to 2000.
- Custom file format for loading and saving design, machining plans and images.

CAM WIZARD FEATURES

Material selector - customisable materials define cutting feeds, speeds and cutting depth.

Machining plans - easily create and rearrange any number of machining plans from the following types:

- Follow - follow the shapes path ideal for Engraving and Laser Cutting.
- Inside Offset - offset cutter path inside shape(s) with automatic island recognition.
- Outside Offset - offset cutter path outside shape(s).
- Area Clearance - multiple offset cutter paths inside the shape(s).
- Raster Clearance - create a raster path at any angle to clear the inside of shape(s).
- Drill - select point, circle or arc centres for drilling operations.

Post Process - final tool path can be simulated quickly in 2D then posted (G code) to a variety of machines via the customisable post processor.

V-CARVE EXTENSION

The advanced V-Carve extension is now included as standard with QuickCAM 2D Design and enables 3 additional CAM features:-

- **V-Carve** – allows shapes and text to be machined at the correct width by automatically controlling the depth of cut of the V cutter.
- **V-Carve Clearance** – allows larger shapes (wider than the V cutter) to be machined by adding an area clearance path within the shape.
- **Add Tabs** – allows parts to be retained while cutting through a billet. The size, number and depth of the Tabs can be user-defined.

RECOMMENDED SYSTEM REQUIREMENTS

See page 39.

QuickCAM PRO

ADVANCED MILLING CAM SOFTWARE

INCLUDES NEW
F1 CAR WIZARD

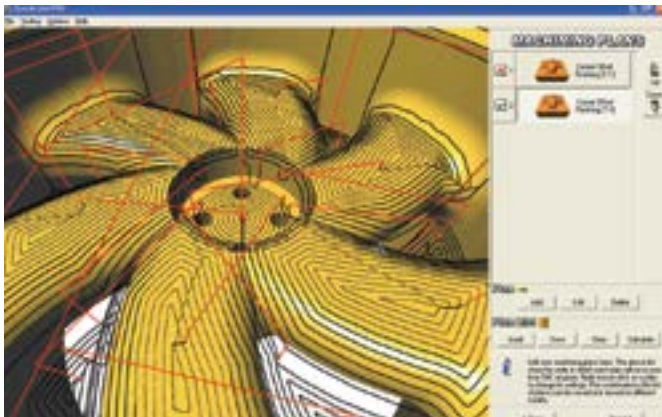

QuickCAM Pro is an advanced, yet simple to use, wizard based CAM package, which is used to create cutter paths for machining 3D parts on a milling machine or router. Both STL files and image files can be imported into QuickCAM Pro, and a comprehensive set of machining plans can be used individually or in combination to produce complex 3D surfaces and lithophanes.

NEW

The latest release of QuickCAM Pro includes the new F1 Car Wizard, which simplifies the process of creating the CNC file to cut both sides of an F1 car.

Simply progressing through the pages of the Wizard allows the program for both the left and right hand side of the car to be created in one easy operation.

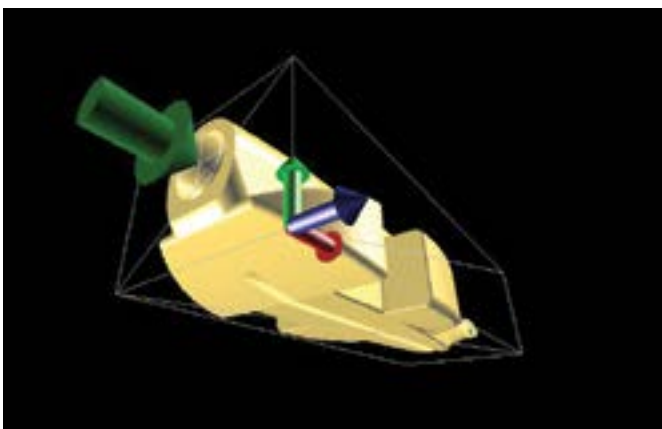

Ideal for use in conjunction with **in Schools**

QuickCAM PRO

FEATURES

12 machining plans – use individually or in combinations:

- **3 Roughing Plans.**
- **6 Finishing Plans.**
- **3 Fine Finishing Plans.**

Each plan can be customised or used with default values.

Any number of plans can be used to produce the final part.

Different cutters can be used with each plan.

Simulation mode can be toggled on or off for easy viewing.

Custom boundary feature allows selected area to be machined.

Viewer and simulation colours can be selected and changed.

Finished models can be rendered in custom materials.

Intelligent scaling fits model into billet or billet around model.

Comprehensive “show me” files to provide Help options.

SUPPORTED INPUT FORMATS

3D Stereo Lithography (STL) files, as created with 3D design packages.



RECOMMENDED SYSTEM REQUIREMENTS

1 GHz Processor,
 1 GB Memory,
 32 GB Hard Disk,
 Microsoft Windows 7, 8 & 10,
 OpenGL Graphics Card, or built in Graphics,
 to support a minimum 1024 x 768 Screen Resolution,
 CNC machines require USB Connection.



VR CNC Milling 5

CNC MACHINE CONTROL SOFTWARE

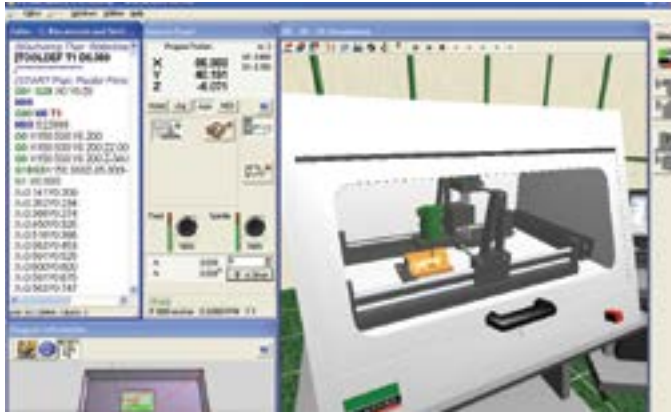

Tool and Offset Editor

Work Offsets Tooling Data Tool Library

No.	Descriptor	Z Offset	Diameter	Type	Length	Flute Len
1	Slot Drill 8 mm	0.000	8.000	Slot Drill		
2	Slot Drill 6 mm	0.000	6.000			
3	Slot Drill 5 mm	0.000	5.000			
4	Slot Drill 4 mm	0.000	4.000			
5	Slot Drill 3 mm	0.000	3.000			
6	Slot Drill 2 mm	0.000	2.000			
7	Slot Drill 10 mm	0.000	10.000			
8	Slot Drill 1.5 mm	0.000	1.500			

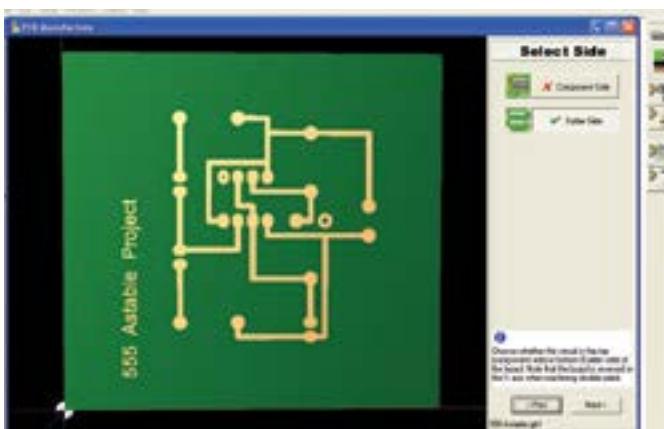
Virtual Reality (VR) CNC Milling 5 is an improved and updated version of our CNC machine control software incorporating Denford PCB Manufacturing Software and 2D DXF import facilities, together with USB connectivity, delivering machining times up to 40% faster than before. Enhanced features provide the user with new machining capabilities, simplified options in datum setting, improved tool and work offset features and a new, powerful, virtual reality 3D simulation engine.



Ideal for use in conjunction with

in Schools

VR CNC Milling 5

PROGRAMMING FEATURES

- Program information screen provides fast interactive 3D depiction of tool path.
- Powerful NC code editing options.
- Program pre-scan checks for syntax errors and invalid codes prior to machining.
- Utilities toolbar provides seamless integration with other Denford applications.
- Simplified tool editing with multiple tool types.

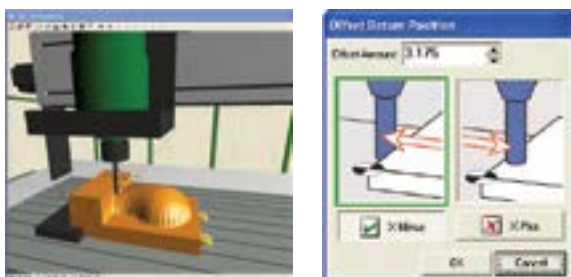

VR SIMULATION FEATURES

- Simulate real machining with highly detailed Virtual Reality.
- Actual cutting of the virtual material in jog mode or program cycle.
- Tables, bases and workholding fixtures are simulated.
- Collision detection: objects change colour when cutter comes into contact with billet, workholding or tables.
- Virtual feed & speed overrides can control the virtual machine.
- Auto datum facility: Program can run without having to set the VR offsets.

MACHINE CONTROL FEATURES

- USB connectivity – Faster Data Transfer.
- Continuous Path Manufacturing system pre-examines CNC moves to determine optimum change of direction.
- One click datum positioning.
- Material override mode – Automatically adjusts program feeds & speeds from a pre-set menu.
- Intelligent program restart window allows restart of program from any line.
- Denford Post Processor allows translation of NC programs between different controllers.

RECOMMENDED SYSTEM REQUIREMENTS

Please refer to page 39.

VR MILLING PCB IMPORT

Simple “Wizard” program with 3D Graphics. Imports Gerber files from all major PCB design packages. Imports Drill files from all major PCB design packages. Multi pass machining strategy increases clearance around tracks. Option to create drilling plan from pad hole diameters. Option to centre pads, pilot holes or drill all holes. Handles double sided boards. Toolpath simulation.



VR MILLING 2D DXF IMPORT

- Simple “Wizard” program with 2D Graphics.
- Integrated Material and Tool Library.
- Imports DXF and DWG files from all major CAD packages:- TechSoft, Pro/DESKTOP, ArtCAM, AutoCAD, CorelDraw etc.
- Multiple cutter path strategies including:
 - Follow Path.
 - Inside Offset (cutter path offset by radius).
 - Outside Offset (cutter path offset by radius).
 - Area Clearance (Offset by outline) with programmable step-over.
 - Area Clearance (Raster) with programmable step over and angle.
 - Drilling cycles.
- Intelligent selection of Islands.
- Toolpath simulation.

SEAMLESS IMPORT OF TECHSOFT 2D DESIGN FILES:

The import routine with Denford’s VR CNC Milling V5 operating software works with Techsoft 2D Design Tools Versions 1 & 2 and also with ALL major CAD packages.

It is far more advanced than the Techsoft post-processor, supplied with Techsoft Version 1 and is far simpler to use.

ALL Denford machines operating with VR CNC Milling V5 are able to import designs drawn in Techsoft Versions 1 & 2, saved in DXF format, **without any additional software or post processor being required.**

VR Milling V5 has the facility to import DXF, DWG and Gerber files, which then allows multiple toolpaths to be created. The toolpaths are generated using the vector data imported and not colours, fill or line width.

QuickTURN 2D DESIGN

CAD/CAM DESIGN AND MANUFACTURE
SOFTWARE FOR LATHES

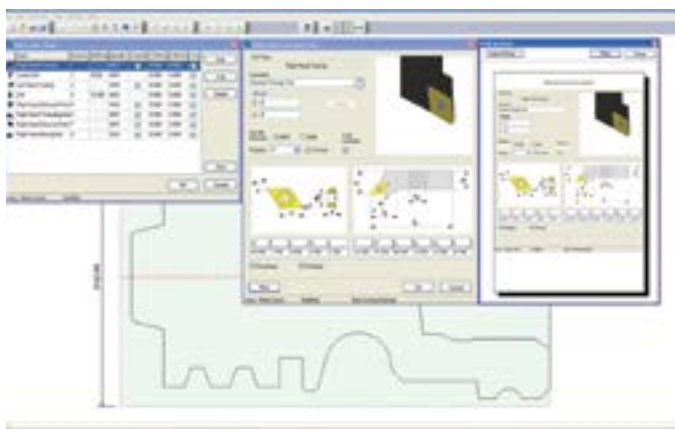
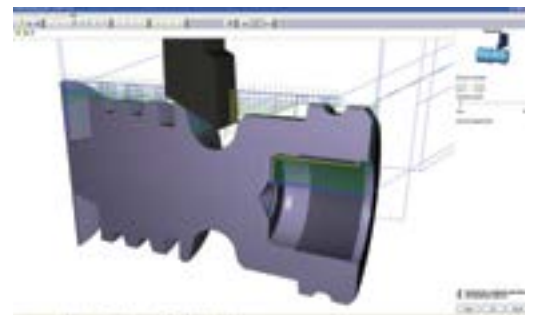
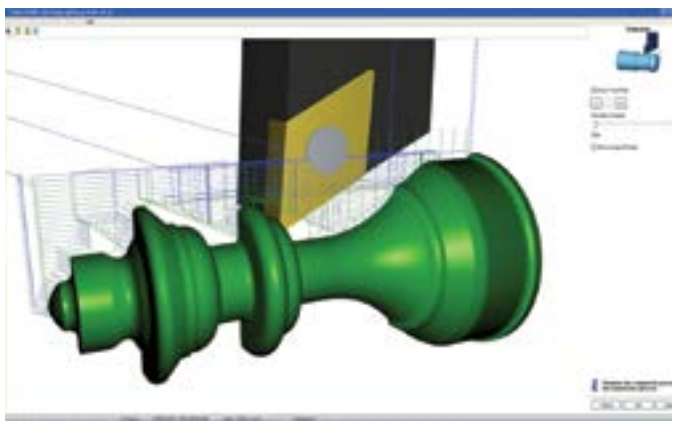
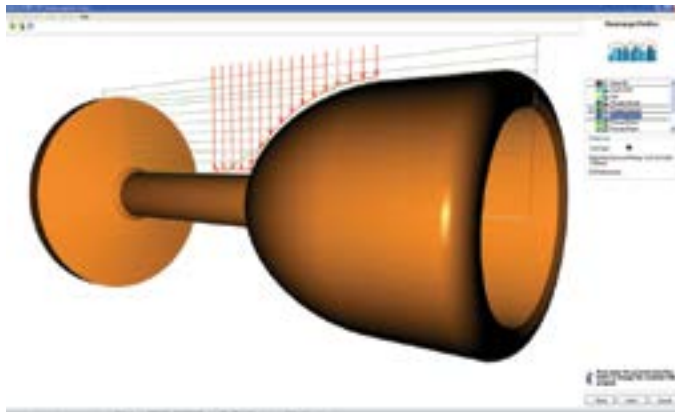

QuickTURN is an advanced yet simple to use, wizard based CAD/CAM package for Lathes. You can create or import 2D profiles, configure your tooling and material settings, then run the CAM wizard to create and simulate CNC Lathe toolpaths. The software features fully automatic toolpath generation, picking the most suitable tool from those available.

QuickTURN 2D Design

PROFILE DRAWING FEATURES

- Create lines, arcs and threads on external and internal profiles.
- Geometry is limited to the billet size and interacts with the rest of the profile to inhibit the creation of profiles that would be impossible to machine (eg, overhangs or breaking through from the internal profile).
- DXF file import wizard allows designs from other CAD software to be turned into a profile ready for the CAM wizard.
- Profile items can be edited interactively on screen, or by the property editor.
- Profile dimensions update constantly.

TOOLING AND MATERIAL OPTIONS

- The tooling editor allows a wide range of tool types to be edited or created and features a live 3D preview of the tool.
- The shape and size of tool tips and holders can be defined exactly as they are in the real world for a more realistic simulation.
- Tools can be quickly deactivated so the CAM wizard will not pick them.
- Material types can be configured quickly and easily to include feed, speed and cut depth settings for each of the tools available.
- Default feed and speed settings for all tool types can be edited quickly by a unique override slide bar.
- Tooling and material details can be printed out in summary or full detail.

RECOMMENDED SYSTEM REQUIREMENTS

1 GHz Processor,
 1 GB Memory,
 32 GB Hard Disk,
 Microsoft Windows 7, 8 & 10,
 OpenGL Graphics Card, or built in Graphics,
 to support a minimum 1024 x 768 Screen Resolution,
 CNC machines require USB Connection.

CAM WIZARD FEATURES

Material selector to alter feed, speed and cut depths.

Billet material size editor in case the actual material is larger than the design.

Tooling selector quickly allows certain tools to be deactivated.

Toolpath generator automatically picks the tools and creates all internal/external cutting and threading operations.

Tool nose radius compensation is automatically applied to the generated toolpath for any turning, boring and grooving tools.

A 3D preview of the design also shows the generated toolpaths.

Each set of toolpaths can be deactivated if not required by the rearrange profile editor.

Toolpaths are post-processed to a CNC file suitable for a Denford Lathe.

A fully animated 3D cutting simulation of the tool paths lets you verify that the CNC program is ok.

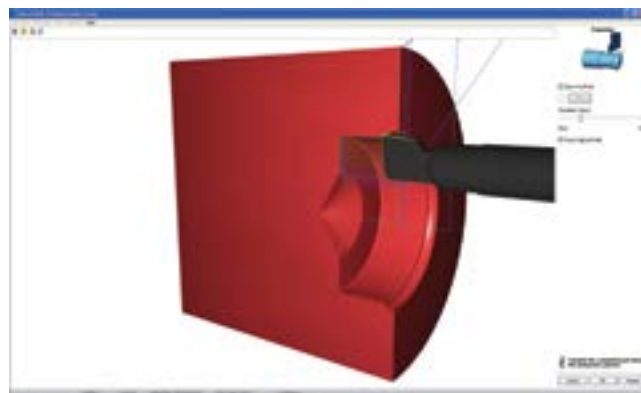

VR CNC Turning

CNC MACHINE CONTROL SOFTWARE

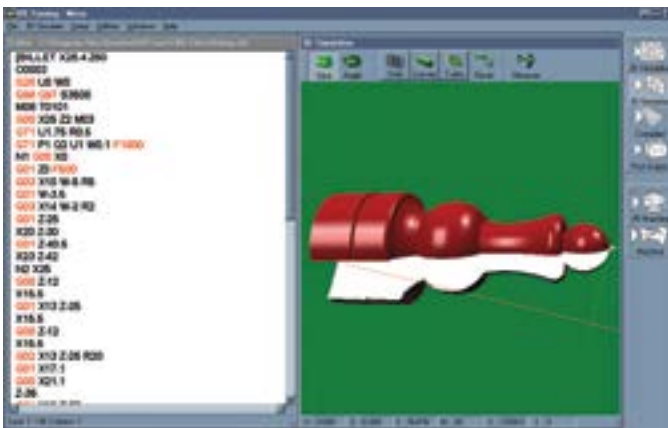
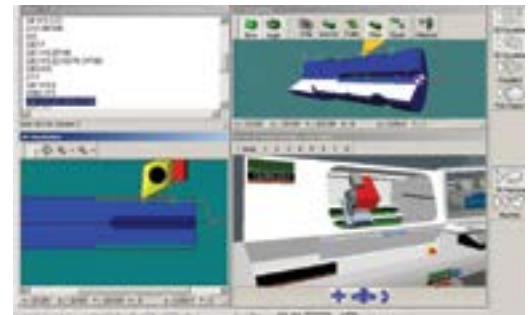

VR CNC Turning is a Virtual Reality based CNC programming software package offering full machine control and Virtual Reality simulation of CNC Lathes. Features include customisable docking toolbars, comprehensive tooling management, colour formatting of NC code & powerful NC code modification options.

VR CNC Turning

PROGRAMMING FEATURES

- Customisable docking toolbars.
- Comprehensive tooling management.
- Colour formatting of NC code.
- Powerful NC Code modification options.
- Context sensitive G&M code help.



VR SIMULATION FEATURES

- Dynamic rotation/zooming.
- Colour coded move types and tooling.
- Built in Virtual Micrometer to measure the simulated workpiece.
- Unique "SourceTrack" technology for interaction between graphical data and NC Code.



MACHINE CONTROL FEATURES

VR CNC Turning is recommended for physical control of the full range of Denford CNC Lathes. Password protected machine parameters allows tailoring to suit individual machines.

The Denford Post Processor allows translation of NC programs between different controller types.



VIRTUAL REALITY FEATURES

Virtual Reality control encourages students to familiarise themselves with machining processes before physical manufacture. Includes a fully working Automatic Turret and library of machine options.

RECOMMENDED SYSTEM REQUIREMENTS

1 GHz Processor,
 1 GB Memory,
 32 GB Hard Disk,
 Microsoft Windows 7, 8 & 10,
 OpenGL Graphics Card, or built in Graphics,
 to support a minimum 1024 x 768 Screen Resolution,
 CNC machines require USB Connection.

Virtual Wind Tunnel

F1 VWT ANALYSIS SOFTWARE MK7

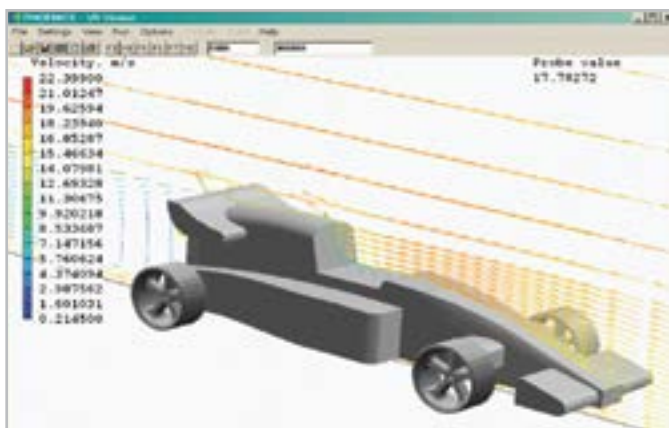
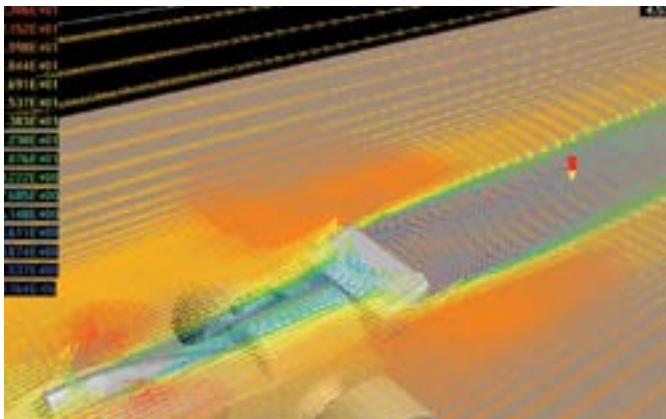
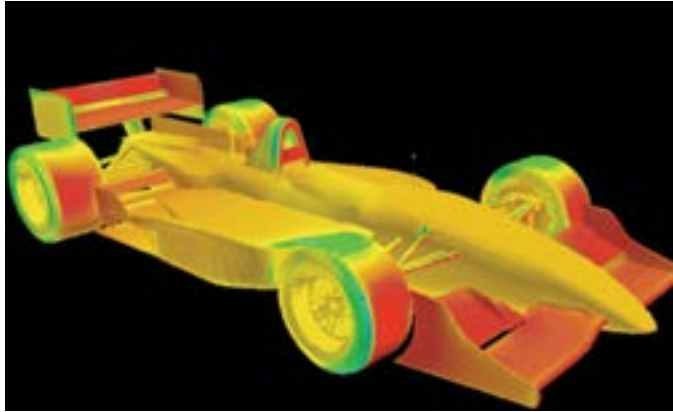

New Features:

- Automatic result output
- Simulated wheel spin and CO2 exhaust gas
- Direct CAD import
- Geometry live update – see changes as you update
- Quicker simulation times
- More accurate shape detection

VWT Mk7 is a Virtual Wind Tunnel Software, which allows students to easily analyse the aerodynamic characteristics of their car design, using Computational Fluid Dynamics (CFD), which is an integral part of the design process for racing car manufacturers and teams. It is used to streamline the car's shape by predicting its levels of drag and downforce, which can then be optimised to ensure aerodynamic efficiency and that all 4 wheels remain firmly on the ground!



Ideal for use in conjunction with

in Schools

Virtual Wind Tunnel

For those involved in the F1 in Schools STEM Challenge, the process is simple - students design their F1 car with 3D CAD software such as Autodesk and then export the STL file into the Virtual Wind Tunnel software. The design is then displayed on-screen, allowing students to begin testing the designs for velocities, pressures, areas of turbulence, lift and drag by using vector plots, contour plots, streamlines and isosurfaces.

The Virtual Wind Tunnel Software uses a process called Computational Fluid Dynamics or CFD. This is basically the prediction of processes involving fluid flow, heat and mass transfer, chemical reaction and/or combustion. Anything that involves fluid flow can be simulated using these techniques, with varying degrees of accuracy.

CFD is based upon the laws of physics, of conservation of mass, momentum and energy. The equations are embodied within a mathematical model and solved using a grid superimposed on the region of interest. For the F1 in Schools STEM Challenge, this will be the "Analyse" stage of your team's Design, Analyse, Make, Test and Race process – towards racing success!

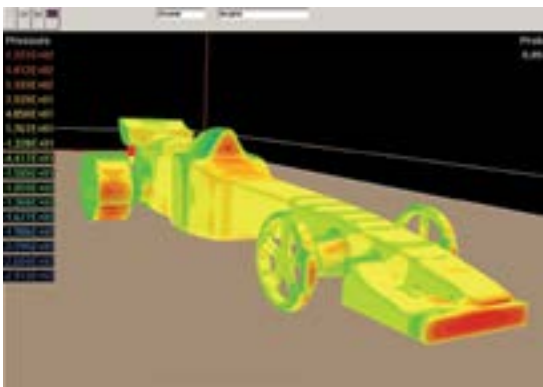

VWT Software Mk7 is designed to fit within your Design and Analyse process. Immediately after finishing a design, easily import the CAD model into VWT, refine geometry locations, enter initial settings and boundary conditions (seeing changes to your simulation model in real time), then run the mathematical solver. Once the simulation is finished, you can analyse your model's performance:

- Downforce and drag on the body of your car
- Data graphs of the whole 3D simulation are ready to export
- Velocity / pressure contour and vector plots, surface contours, iso-surfaces and stream lines

Use these results to improve and optimise your design before race day and ensure that your car is the fastest out there!

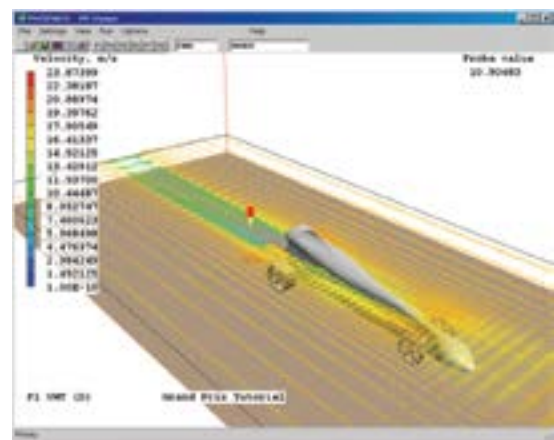

RECOMMENDED SYSTEM REQUIREMENTS

Any standard Windows PC: Vista, 7, 8 & 10

The software is both CPU- and RAM-intensive, but 3GB RAM should suffice [more is better]

3GHz processor speed [minimum]

No special graphics requirements

The software will run on both 32bit and 64bit PCs

VLS Series Lasers

LASER CUTTERS & ENGRAVERS



VLS Series safety features include Over Temperature Sensor with Audible Alarm, Safety Glass, Automatic Recognition of Accessories and 'Smart Technology' ULR Laser Cartridges which can be easily changed by the user. VLS Series Laser Systems are RoHS Compliant.

EXCLUSIVE

Denford Advantage Extraction Unit with integrated Air Assist Compressor

For LaserCAM 2D Design Software
see pages 34 - 35



Choice of 5 colours

VLS Series Lasers can transform images or drawings on your computer screen into real items made from a wide variety of materials. These Lasers are ideal for cutting, deep engraving, precision scribing, decorative etching on wood, plastic, fabric, leather, paper, rubber and will also mark glass, ceramic, metal and stone.



VLS Series Lasers

There are two bed sizes to choose from and 5 power options available to accommodate a variety of budgets and applications. The VLS Series' access door and side panels come in a variety of colours including red, green, blue, yellow or purple.

Optional equipment includes a Honeycomb Bed, Extraction Unit with integrated Air Assist Compressor, Rotary Fixture and High Density Focusing Optics. An Air Assist Back Sweep is available for use when cutting rubber.

VLS Series Lasers have a unique 'materials cutting' menu so there is no need to look-up power and speed settings - simply select the type of materials and thickness to be lasered and press the start button. Design and Print, it's as simple as that!

VLS Series Lasers are recommended for use with the Denford Advantage Extraction Unit with integrated Air Assist Compressor, Pre Filter and HEPA Chemical Gas Filter, which can be visually monitored by a 3 stage Filter Status Display. The unit is portable and will pass through a standard width doorway.



RECOMMENDED SYSTEM REQUIREMENTS

Dedicated PC: Windows 7, 8 & 10, 32-bit/64-bit
1 available USB Port (2.0 or higher)

ROTARY FIXTURE - OPTIONAL

The Rotary Fixture permits laser processing around cylindrical surfaces up to a maximum 127mm (5.0") diameter. A sensor detects when the fixture is installed and adjusts automatically.



MACHINE DETAILS	VLS2.30	VLS3.50	ADVANTAGE UNIT
Machine Length	661mm	864mm	670mm
Machine Depth	635mm	635mm	470mm
Machine Height	356mm	356mm	770mm
Machine Height on Advantage Unit	1118mm	1118mm	N/A
Machine Weight	32kg	43kg	65kg
Approx. Working Area	305 x 406mm	305 x 610mm	N/A
Watts of Laser Power	10, 25 or 30	10, 25, 30, 40 or 50	N/A
Volts	230 Volts	230 Volts	230 Volts
Amps	10 Amps	13 Amps	7.25 Amps
Electrical Connection	13A Socket	13A Socket	13A Socket

SAFETY INFORMATION

Class I safety enclosure for CO2 laser beam. Class IIIa for red laser pointer.



Large Format VLS Series Lasers

LASER CUTTERS & ENGRAVERS



VLS Series safety features include Over Temperature Sensor with Audible Alarm, Safety Glass, Automatic Recognition of Accessories and 'Smart Technology' ULR Laser Cartridges which can be easily changed by the user. VLS Series Laser Systems are RoHS Compliant.

For LaserCAM 2D Design Software
see pages 34 - 35



Choice of 5 colours

Large Format VLS Series Lasers are free standing laser units with a large working area. There are numerous models and power options available to accommodate a wide range of budgets and applications including cutting, deep engraving, precision scribing, decorative etching on wood plastic, fabric, leather, paper, rubber and also the marking of glass, ceramic, metal and stone.



Large Format VLS Series Lasers

Optional equipment includes a Honeycomb Bed, Extraction Unit with integrated Air Assist Compressor, Rotary Fixture and High Density Focusing Optics. An optional Air Assist Back Sweep is available for use when cutting rubber.

VLS Series Lasers have a unique 'materials cutting' menu so there is no need to look-up power and speed settings - simply select the type of materials and thickness to be lasered and press the start button. Design and Print, it's as simple as that!

Large Format VLS Series Lasers are recommended for use with the Denford AD-ORACLE Extraction Unit with integrated Air Assist Compressor, Pre Filter and HEPA Chemical Gas Filter, which can be visually monitored by a Filter Status Display.

RECOMMENDED SYSTEM REQUIREMENTS

Dedicated PC: Windows 7, 8 & 10, 32-bit/64-bit
1 available USB Port (2.0 or higher)

ROTARY FIXTURE - OPTIONAL

Permits laser processing around cylindrical surfaces up to 203mm (8.0") diameter and up to 406mm long.



AD-ORACLE
Extraction Unit



Automatic Driver

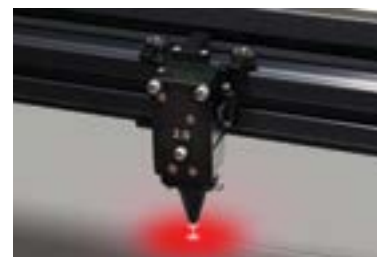

Optics with Air Assist

MACHINE DETAILS	VLS3.60	VLS4.60	VLS6.60	AD-ORACLE Extraction Unit
Machine Length	914mm	914mm	1118mm	430mm
Machine Depth	762mm	914mm	914mm	430mm
Machine Height	965mm	965mm	991mm	980mm
Machine Weight	107kg	122kg	147kg	90kg
Approx. Working Area	305 x 610mm	457 x 610mm	457 x 813mm	N/A
Watts of Laser Power	10, 25, 30, 40, 50, 60	10, 25, 30, 40, 50, 60	10, 25, 30, 40, 50, 60	N/A
Volts	230 Volts	230 Volts	230 Volts	100 - 240 Volts
Amps	10 Amps	10 Amps	10 Amps	12.5 Amps
Exhaust Connections Dia.	101.6mm	101.6mm	2 x 101.6mm	75mm
Electrical Connection	13A Socket	13A Socket	13A Socket	13A Socket

SAFETY INFORMATION

Class I safety enclosure for CO2 laser beam. Class IIIa for red laser pointer.

F1 in Schools Packages

COMPLETE PACKAGES INCORPORATING DESIGN, ANALYSE, MAKE, TEST & RACE

The F1 in Schools STEM Challenge stimulates a student's interest in, and understanding of the entire process of design and manufacture. Through involvement in the F1 in Schools Challenge, students will gain first hand experience of teamwork and communication, whilst encouraging individual flair and confidence. The F1 in Schools STEM Challenge provides students with the opportunity to reflect industrial working practice of developing a product from concept, to prototype to production.

Plan



Design

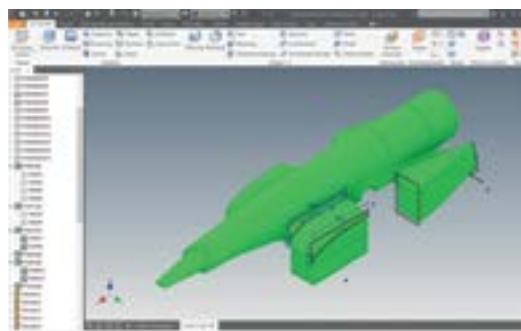

Analyse



Make



Test



Race



flinschools.com



APPROVED

Ideal for use in conjunction with



in Schools

F1 in Schools Packages

In support of the F1 in Schools STEM Challenge, Denford offers F1 in Schools Packages, which include all of the equipment required to get you up and running for this innovative educational project - covering Design, Analyse, Make, Test & Race.

A brief overview:

1. Plan: Prepare a **business plan**, develop a budget and raise sponsorship. Teams are encouraged to collaborate with industry and create business links.

2. Design: Using 3D CAD (Computer Aided Design) software, **design** an F1 car of the future to the specifications set by the International Rules Committee just like in Formula 1.

3. Analyse: Aerodynamics are **analysed** for drag coefficient in a Virtual Reality Wind Tunnel using Computational Fluid Dynamics Software (CFD).

4. Make: Using 3D CAM (Computer Aided Manufacture) software, the team evaluates the most efficient machining strategy to **make** the car.

5. Test: Aerodynamics are **tested** in wind and smoke tunnels.

6. Race: Time to test what your team has worked so hard together to achieve: a **winning car**.

1 - F1 Car Manufacturing Package:

DESIGN:

Autodesk® 3D Design, Drafting & Simulation Software
QuickCAM Pro Advanced Milling/Routing CAM software (site licence).

ANALYSE:

Virtual Wind Tunnel (VWT) Software (single licence).

MAKE:

CNC Machine Options

- Router 2600/Router 2600 Pro (Metal Cutting).
- Compact 1000/Compact 1000 Pro (Metal Cutting).

Car Manufacture Fixture

F1 in Schools Car Manufacturing Fixture

Consumables

F1 Model Block - Pack of 20.
F1 Class Wheels - Pack of 100.
Screw Eyes - Pack of 100.
F1 Axles - Pack of 100.
Axle Bushes - Pack of 100.
Decal Stickers - Pack of 25 sheets.
Paint Stand.
2 x 1/4" Dia. Ball Nose Extra Long Series Cutter.
IsoSketch 3D Drawing Tool - Class pack of 30.

2 - F1 Car Manufacturing, Test & Race Package:

This package includes all of the above equipment plus the following:

TEST:

Air Trace Visualisation System

RACE:

F1 Race Track
F1 Race Control System
Denford CO2 Power Packs 8 gms - Pack of 360
Car Deceleration System



Compact 1000 Pro



Router 2600 Pro

For the full range of F1 race equipment & consumables see pages 60 - 65

F1 in Schools STEM Studio

Instant STEM Facility

NEW

The F1 in Schools STEM Studio is an innovative concept, designed to deliver STEM education - launched by F1 in Schools, in partnership with Denford and Technology Supplies - offering high-quality equipment and resources within a dedicated stand-alone classroom workshop.

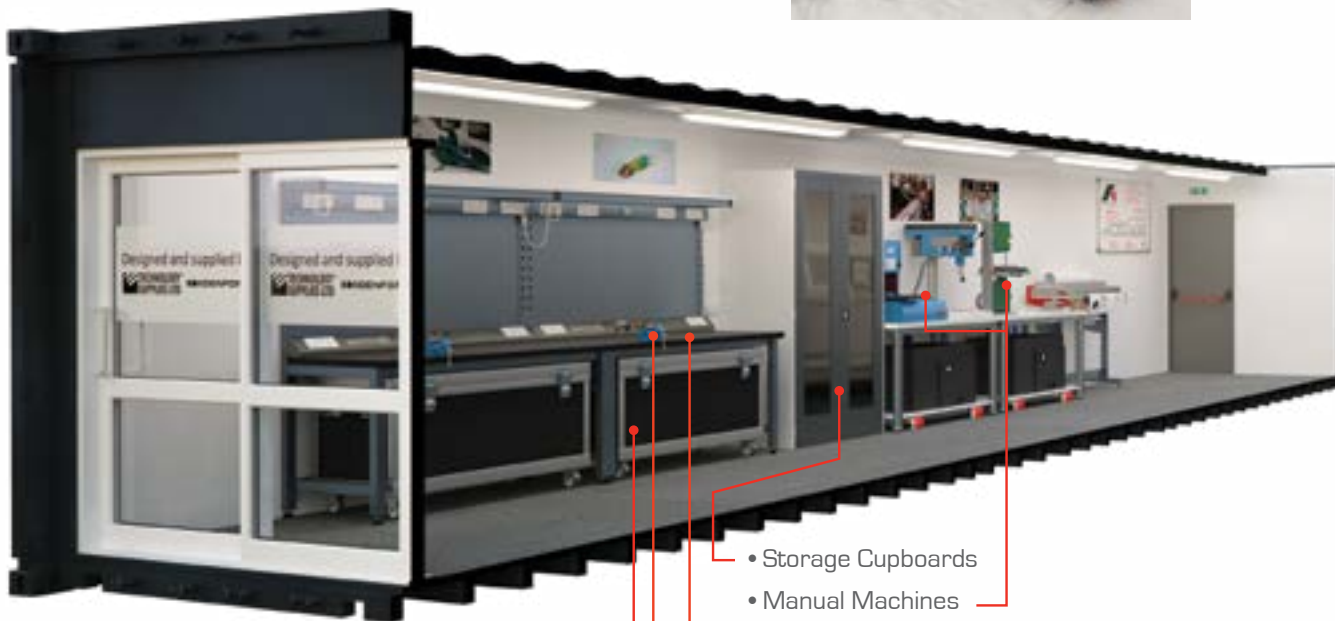

- Storage Cupboards
- Manual Machines
- Benching with Power Trunking
- Small Tools & Consumables Packages
- F1 Race Track in Storage Flight Case

What's inside...

Featuring a collaboration area with audio visual equipment, the air conditioned* STEM Studio incorporates CAD/CAM and woodworking machinery, a laser engraving machine, 3D printers, F1 in Schools Test and Race equipment, as well as work benches with power trunking, storage cupboards and a full complement of hand tools and accessories.

Price includes positioning of the STEM Studio, installation and training.



*The Tropical Version of the STEM Studio is fitted with a higher specified Air-Conditioning System to cope with extreme temperatures

Primarily developed to deliver the F1 in Schools programme, the fully-resourced STEM Studio additionally offers teachers the opportunity to deliver bespoke design & technology / engineering related courses.



NOTE: STEM Studio contents are subject to variation.

The STEM Studio is an ideal instant solution for schools wishing to offer STEM related courses – particularly those in remote locations without access to the resources needed for STEM learning, or where lack of space / facilities may be a restriction.

F1 in Schools STEM Studio requires the following:

- A cabled 3 Phase 415V Power Supply
- A solid flat surface for location

STEM Studio Dimensions:

40ft Long x 9ft 6in High x 8ft Wide

Primary STEM Project

Make STEM learning exciting and fun with this innovative classroom resource!

NEW

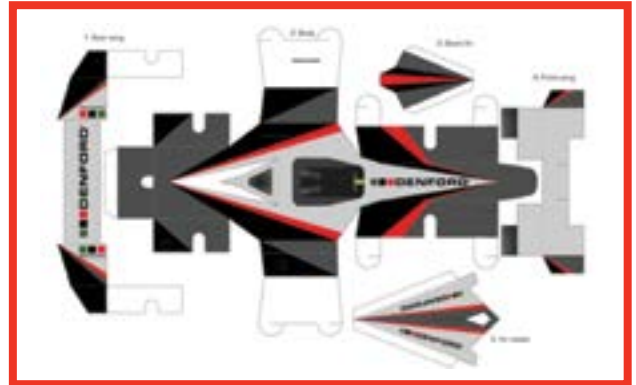

Sow the seeds of STEM learning at an early age with the Denford Primary STEM Project, encouraging Primary Students to develop knowledge and skills through practical, hands-on activities.

What students will learn:

- Science applied to the real world
- How to closely follow instructions
- The design process: research, design, test, improve, repeat
- Teamwork
- Speaking and listening skills
- Recognising personal strengths and the strengths in others





 Ideal introduction to **in Schools**



Primary STEM Project Equipment

Primary STEM Project Pack: ARCP02

Supplied in plastic storage box with lid

Includes:

Primary STEM Project Chassis Net (Pack of 100)

Propulsion Tubes (Pack of 50)

Propulsion Tube End Caps (Pack of 50)

Axle Guides (Pack of 50)

Tether Guide Tubes (Pack of 50)

Primary Project Wheels (Pack of 100) x 2

Axle Bushes (Pack of 100) x 2

Axles (Pack of 100)

Items can be purchased separately

Primary STEM Project Launch System: F1AR001000A

Includes:

Air Launch Control Box

Air Launch Pump – up to 160 psi

Loading Pins

Tether Block Assembly

Tether Guide Line 0.6 mm dia

Primary STEM Project Roll Out Race Track: F1AR/0900

Design - Make - Race

Students start the process by folding a pre-stamped chassis net to make a standard 3D racing car with wheels and axles. Following research, they will design and make a body shell to create their own miniature racing car and go on to test its aerodynamic qualities, using the launch system and roll-out race track, then re-evaluate their designs, to produce a winning car!



LET'S RACE!



Land Rover 4x4 Equipment

STARTER KIT & TRACK ELEMENTS

Land Rover 4x4 in Schools Starter Packs

Land Rover 4x4 In Schools 'Rock Crawler' Pack

Product Code: 4x40001 (Available in UK market only)

Comprising: 1/18 Scale 4WD Rock Crawler, 2.4Ghz Transmitter with Batteries, 1 x Ni-MH Battery Pack, Battery Charger



Note:
Rock Crawler
models may vary

Land Rover 4x4 in Schools Starter Kit

Product Code: 4x40017

The Starter Kit consists of all the essential components needed to get you started in the Challenge, ready for vehicle scrutineering and includes the following key items:-

1/18 Scale 4WD Rock Crawler [4X4001] – see above

1 x Arduino Starter Pack Comprising: 1 x Battery Clip, 1 x Transistor, 1 x Resistor of 1 KOhm, 1 x Resistor of 680KOhm, 1 x Variable Resistor, 1 x LED, 1 x LDR, Wire, 1 x Piezo buzzer

2 x Tilt Sensor, 1 x Lead Free Solder – 250g reel, 1 x Single-Sided Stripboard, 1 x Stripboard Cutter, 1 x Pack of 10 Straight PCB Header – 36 way

Land Rover 4x4 in Schools Track

Land Rover 4x4 in Schools Track

Product Code: 4x40200

Official Land Rover 4x4 in Schools Track comprising full Staging and 14 Track Elements (including 64 entry and exit cones)

Land Rover 4x4 in Schools Half Track: 6 Elements Only

Product Code: 4x40250

Includes: Articulation, V-Gully Traverse, Pipe Bridge, See Saw, Hill Climb, Side Slope

Land Rover 4x4 in Schools Flight Case for Track Elements

Product Code: 4x40191

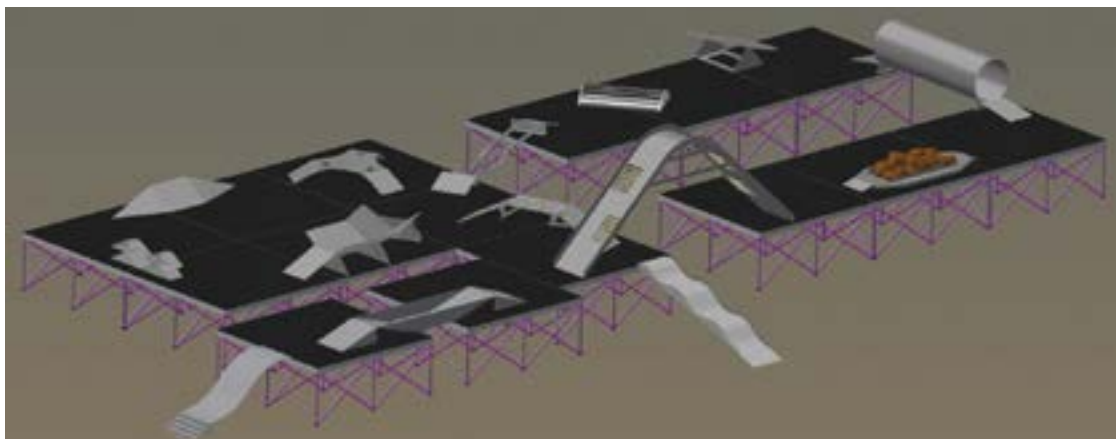



ABOVE & BEYOND



4x4 IN SCHOOLS

Land Rover
4x4 in Schools
Track Elements



Entry Ramp



Camber Dome



Articulation



V-Gully Traverse

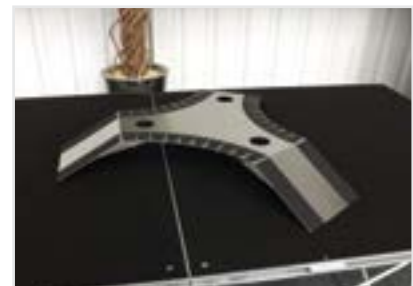

Hub



Pipe Bridge



Tunnel



See Saw



Off Ramp



Hill Climb



Low Mu Traverse



Side Slope



Rock Crawl



Water Tank Test



F1 in Schools Equipment

RACE EQUIPMENT & CONSUMABLES



As Proud Founder and Sponsor of F1 in Schools, Denford is delighted to be the official supplier of the latest F1 in Schools Race Equipment and Consumables.

The company has developed a complete range of cutting edge equipment, designed and manufactured in the UK by Denford, to support the F1 in Schools Challenge, including a lightweight, portable Race Track and a Start Gate with clear display and data storage. The Air Trace Visualisation System is also a valuable asset for aerodynamic capability analysis and for demonstrating this in the classroom.

This range of equipment was launched at the World Finals in Malaysia in 2017, where it proved to be a resounding success with the teams; and Denford continues to enhance and develop the equipment to meet the technological demands of competing students and to future-proof the F1 in Schools STEM Challenge.

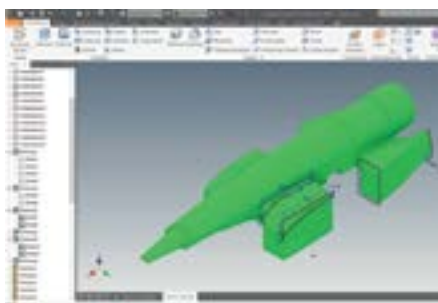

DESIGN

AUTODESK.

3D Design Software

Design your car using Autodesk® 3D Design Software. Autodesk and F1 in Schools have partnered to offer design tools to help prepare next-generation designers. Students and schools participating in F1 in Schools can access an extensive portfolio of Autodesk® 3D Design Software free of charge. To register for your software, please visit: www.f1inschools.com/software.html

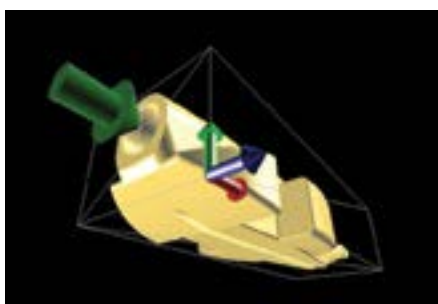

QuickCAM Pro

QuickCAM Pro provides the link between your 3D design software and the Denford range of CNC Routers. The latest release of QuickCAM Pro includes the new F1 Car Wizard, which simplifies the process of creating the CNC file to cut both sides of an F1 car.

Site Licence

BI01806P

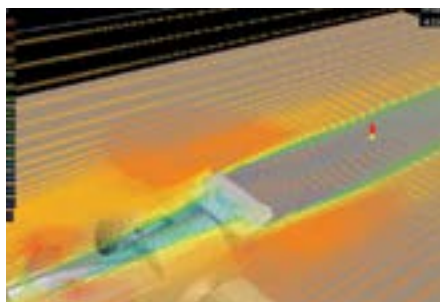

ANALYSE

Virtual Wind Tunnel Software

F1 WWT Analysis Software Mk7

Single Seat

5 User Licence

Site Licence

BIO1841

BIO1841A

BIO1841C



MAKE

CNC Machine Options for F1 Car Manufacture:

Compact 1000

Compact 1000 Pro (Metal Cutting)

Router 2600

Router 2600 Pro (Metal Cutting)

Router 6600

Router 6600 Pro (Metal Cutting)

MRC002000A

MRC003000

MRP002000

MRP003000

MRFO02000

MRFO03000



F1 in Schools Car Manufacturing Fixture

To enable the manufacture of Formula 1 Class cars. The fixture clamps directly to the T-slotted table on the Compact 1000/Pro, Router 2600/Pro and Router 6600/Pro and is also suitable for use on the VMC 1300 [it is necessary to remove the tool changer to fit the fixture]

NR1/0400UA



F1 Entry / Development Class Starter Kits

SOLO

1 x F1 Model Block Car Kit

1 x IsoSketch 3D Drawing Tool - single blister pack

F1DKIT01

TEAM

5 x F1 Model Block Car Kit

5 x IsoSketch 3D Drawing Tool - single blister pack

F1DKIT05

GROUP

10 x F1 Model Block Car Kit

1 x IsoSketch 3D Drawing Tool - class pack of 30

F1DKIT30



F1 Model Block (pack of 10)

This official F1 Model Block measures 223mm x 65mm x 50mm, with a consistent weight and density, and contains a pre-drilled hole for the CO2 Power Pack.

F1223/10

F1 in Schools Equipment

RACE EQUIPMENT & CONSUMABLES



MAKE

F1 Class Wheels

F1 Class Wheels - Black (pack of 100)

NX4531



F1 Model Block Car Kit

Includes 4 x F1 Class Wheels, 1 x Sandpaper, 2 x Screw Eyes, 2 x F1 Axles, 4 x Axle Bushes, 1 x F1 Model Block

N13226F1M01



Screw Eyes

Use these screw eyes to keep your car on the track
Screw Eyes (pack of 100)

N16020



F1 Axles

Use the strength of steel to mount your model wheels
F1 Axles - 66mm (pack of 100)

N16010



Axle Bushes

1/4" OD for use with F1 Axles (pack of 100)

NX4532



Paint Stand

The new, improved design holds your car during the painting process. The car is suspended by the cartridge hole and once in the stand, can be rotated to paint all sides

N54528

TEST



Air Trace Visualisation System

Includes Air Trace Visualisation Tunnel and Air Trace Smoke Generator with Air Trace Fluid

F1AT001000



**Air Trace Smoke Generator
(inc. 500ml bottle of Air Trace Fluid)**

Complete with Custom Polycarbonate Nozzle and 2 x Smoke Distribution Rake Attachments
Supplied in robust carry case

BI06006

Air Trace Fluid (500ml bottle)

N56806

F1 in Schools Equipment

RACE EQUIPMENT & CONSUMABLES

RACE



F1 Race Track

23. 65 Metre-long Track (11 sections and 12 legs) with screen printed start and finish sections

F1RT001000B

Flight Case for F1 Race Track

F1RTFC



F1 Race Control System

For use with the F1 Race Track, the F1 Race Control System includes:

1 x F1 Start Gate, 1 x F1 Finish Gate with F1 branded wraps, 2 x F1 Start Boxes and 2 x F1 Start Triggers

F1RS001000B

Flight Case for F1 Race Control System

F1RSFC

Flight Case for F1 Race Control System & Sector Gate

F1RSFC-SG



F1 Race System Package

Includes:

1 x F1 Race Track with screen printed start and finish sections,
1 x F1 Race Control System with F1 branded wraps on Start and Finish Gates

PKFF1B



F1 Sector Gate Timing System

Additional Timing Gate for use with F1 Race Control System (not Stand Alone). The Sector time is recorded by the Race System and will allow car acceleration and deceleration graphs to be calculated.

Can only be used with the new F1 Race Track

F1RS003000



F1 Race Control System - Stand Alone

Stand Alone Race System can be used as a floor mounted Race System, or mounted on the old-style Track. Standard F1 Race Control System with additional Finish Sensor Gate and Cables to mount the Timing Sensors, with F1 branded wraps

F1RS002000B



F1 Start Box

Single Start Box for F1 Race Control System

F1RS/0400



Denford CO2 Power Packs

Denford CO2 Power Packs 8 gms (pack of 360)

F1CO2ST

Standard



Denford Race CO2 Power Packs

Denford CO2 Power Packs 8 gms (pack of 360)
(separately weighed to guarantee a race weight range of within 0.5 grams)

F1CO2CMP

Race



Car Deceleration System (for new F1 Race Track)

The car deceleration system consists of tapered brushes which gradually slow cars down after they have crossed the finishing line

F1CDS001001



F1 in Schools Track Banners (for new F1 Race Track)

Track Banners for use with F1 Race Track, featuring chequered flag borders, F1 in Schools logo and Denford logo

F1RTB

Denford Consumables

MATERIALS & CONSUMABLES



WOOD

A range of hardwoods suitable for machining on Denford Routers.

American Maple Wood Block

A creamy white hardwood with a close grain and fine, even texture.

Easy to work and finish, without the need for sanding.

Billet size: 160mm x 100mm x 20mm	Each	BI03509D
	Pack of 50	BI03509G



Round Pine Billets

Ideal for use with the Rotary Fixture attachments.

Billet size: 65mm Dia. x 150mm Long	Pack of 10	BI03509J
-------------------------------------	------------	----------



FOAM

These rigid, closed cell foam blocks are ideal for the rapid machining of parts on the full range of Denford Milling Machines and Routers.

High Density Foam

Ideal for most 3D prototyping applications. Offering plenty of surface detail, it is commonly used in moulds for vacuum forming and is also suitable for painting.

Billet size: 150mm x 110mm x 50mm	Each	BI03508
	Pack of 50	BI03508A

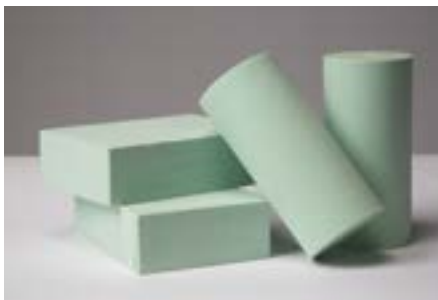

Billet size: 70mm Dia. x 150mm long	Each	BI03508DZ
	Pack of 15	BI03508E

Ideal for use with the Denford 4th axis programmable rotary fixture.



Model Foam

A low density and low cost foam product with easy machining properties which is particularly suitable for quick 3D realisation of design ideas.

Billet size: 160mm x 100mm x 50mm Each BI03508B



MODELLING BOARD

A high density (0.47gms per cubic metre) board ideal for high definition 3D work.

Modelling Board

For prototyping high quality models

Billet Size: 1500mm x 500mm x 50mm Each BI03508K



PCB BOARD

Ideal for use in conjunction with VR CNC Milling 5, PCB manufacturing feature.

Copper Coated Clad PCB Board (Single Sided)

Size: 233.4mm x 160mm x 1.6mm Each 4X40079



Photo Resist Coated PCB Board (Single Sided)

High quality dip coated positive working photoresist. This high resolution photoresist contains a dye which gives a good contrast against the copper allowing boards to be easily inspected at the developing stage. Panels are protected by a specially designed light-proof blue film which allows them to be guillotined without the risk of fracturing the photoresist.

Size: 233.4mm x 160mm x 1.6mm Each 4X40080

Denford Consumables

MATERIALS & CONSUMABLES



ALUMINIUM

Free cutting aluminium bars and billets are ideal for producing quick prototypes of metallic components. Easily polished, they yield professional looking component parts.

Aluminium Bar

Suitable for cutting on Denford Lathes.

Bar Size: 20mm Dia. x 55mm.

Non-Anodised

Each	BI03512A/1
Pack of 50	BI03512A

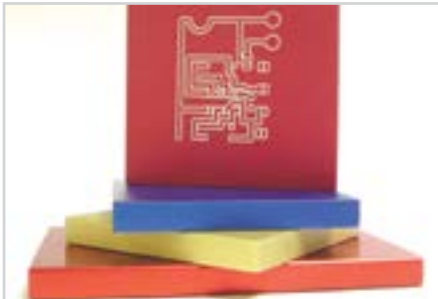

Aluminium Billet

Suitable for cutting on Denford Milling Machines.

Billet Size: 100mm x 100mm x 12mm.

Non-Anodised

Each	BI03511
Pack of 50	BI03511B

Red-Anodised

Each	BI03511A
Pack of 50	BI03511C



EXTRUDED ACRYLIC SHEET

Excellent thermoforming characteristics enabling the production of intricate, delicate shapes.

30 off 3mm **Red** 600mm x 300mm.

BI03523

30 off 3mm **Yellow** 600mm x 300mm.

BI03523A

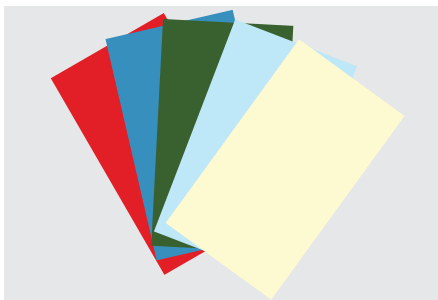

CAST ACRYLIC SHEETS

High quality, perfect surface finish and superb optical qualities.

30 off 3mm **Red** 600mm x 300mm.

BI03522

30 off 3mm **Blue** 600mm x 300mm.

BI03522A

30 off 3mm **Green** 600mm x 300mm.

BI03522B

30 off 3mm **Transparent Blue** 600mm x 300mm.

BI03522C

30 off 3mm **Transparent Yellow** 600mm x 300mm.

BI03522D



HIGH IMPACT POLYSTYRENE

Rigid, easy cutting thermoplastic used for 2D projects. Can be quickly "layered" in different colours to produce low cost nameplates etc. Easily held on temporary machine tables using heavy duty double sided tape.

Billet Size: 160mm x 90mm x 2mm.

White

Pack of 50	BI03501F
------------	----------

Multi-Coloured

Pack of 50	BI03501
------------	---------



ACRYLIC RODS

- 1 metre x 6mm dia. fluorescent round – **Red.**
- 1 metre x 6mm dia. fluorescent round – **Yellow.**
- 1 metre x 6mm dia. fluorescent round – **Green.**
- 1 metre x 6mm dia. fluorescent round – **Blue.**
- 1 metre x 6mm dia. round – **Clear.**

BI03524
 BI03524A
 BI03524B
 BI03524C
 BI03524D



CUTTER PLOTTER CONSUMABLES PACK

- Consumables for projects including:
- coloured vinyl
 - coloured card
 - button magnets
 - mirrors
 - double sided tape

BI01819CRC



DOUBLE SIDED TAPE

Heavy Duty
 Size: 25mm x 33m

Pack of 10 BI03502A

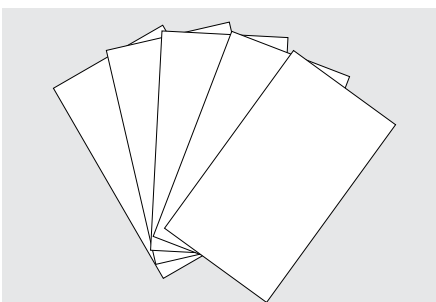

PLOTTER CARD

White Plotter Card (330gsm)
 Size: 450mm x 320mm

Pack of 100 BI01819NE

Denford Consumables

TOOLING, CONSUMABLES & CURRICULUM PACKAGES



TOOLING PACKAGES

Recommended Router Tooling Package

B100846

For all Routers:

- 1/8" Dia x 1/4" Shank 2 Flute Cutter
- 1/8" Dia x 1/4" Shank Ball Nose Cutter
- 1/4" Dia x 1/4" Shank 2 Flute Cutter
- 1/4" Dia x 1/4" Shank Ball Nose Cutter
- 60 Degree V Cutter x 1/4" Shank



Set of Quick Change Toolholders & Collet

B100846SRH

For Compact 1000, Router 2600 and Router 6600:

- 10mm Collet for Kress Motor
- Quick Change Holder 1/4" ID 10mm Shank x 5
- Quick Change Holder 1/8" ID 10mm Shank



Set of Quick Change Toolholders & Collet

B100846PRH

For Compact 1000 Pro, Router 2600 Pro and Router 6600 Pro:

- 9-10mm Dia Collet to suit ER20 Collet Chuck
- Quick Change Holder 1/4" ID 10mm Shank x 5
- Quick Change Holder 1/8" ID 10mm Shank



Quick Change Router Tooling Package - Imperial

MRTPO3

For Compact 1000, Router 2600 and Router 6600:

- 10mm Router Collet for Kress Motor
- 1/4" ID Reducing Bush 10mm Shank x 2
- 1/8" ID Reducing Bush 10mm Shank
- 1/64" Engraving Cutter 1/8" Shank 45 Degrees
- 5/32" 2 Flute Cutter 1/4" Shank
- 1/4" Dia Ball Nose L/S 2 Flute Cutter (Solid Carbide)



Quick Change Router Tooling Package - Imperial

MRTPO4

For Compact 1000 Pro, Router 2600 Pro and Router 6600 Pro:

- 9-10mm Dia Collet to Suit ER 20 Collet Chuck
- 1/4" ID Reducing Bush 10mm Shank x 2
- 1/8" ID Reducing Bush 10mm Shank
- 1/64" Engraving Cutter 1/8" Shank 45 Degrees
- 5/32" 2 Flute Cutter 1/4" Shank
- 1/4" Dia Ball Nose L/S 2 Flute Cutter (Solid Carbide)



Micromill Quick Change Tooling Package - Imperial

MMTP01

Quick Change Tooling Package:

- 1 x 1/8" Dia Toolholder
- 2 x 1/4" Dia Toolholder
- 1/64" Carbide Engraving Cutter 1/8" shank
- 1/8" Dia H.S.S. Slot Drill 1/4" Shank
- 1/4" Dia H.S.S. Slot Drill 1/4" Shank



Micromill Quick Change Tooling Package - Metric

BIO0811TP

Quick Change Tooling Package:

- 3 x 6mm Dia Toolholders
- 2mm Dia H.S.S. Slot Drill
- 4mm Dia H.S.S. Slot Drill
- 6mm Dia H.S.S. Slot Drill



VMC 1300/Pro Tools and Toolholders

VMC/0500RT

Recommended Set of Tools:

- 2mm Ball Nose, 2mm, 4mm & 6mm Slot Drills,
- 20mm End Mill

Recommended Set of Toolholders:

- 2 x 6mm & 1 x 20mm Sidelock Holders,
- 2 x ER32 Collet Chucks with 2 x 6-7mm Collets,
- 1 x ER32 Collet Spanner
- 1 x Hook Spanner to grip spindle while tightening collets

VMC/0500RH



Microturn Tooling Package

MT1/0100B

Recommended Tool Post and Tooling Package:

- Quick Change Tool Post + 3 Toolholders,
- Quick Change Carbide Insert Turning Toolholder and
- Pack of 10 Inserts,
- Parting Off Tool Blade,
- 1 /4" Brazed Carbide Tipped Left Handed Cutting Tool



Turn 270 Pro Comprehensive Tooling Package

TRNCTP

Comprehensive Tooling Package:

- LH Turning Tool 12mm Shank,
- Pack of 10 Inserts for LH/RH Turning Tools,
- Pack of 10 Inserts for Parting Off Tool,
- External Threading Tool 12mm Shank with 10 Inserts,
- Boring Bar 8mm Shank with 10 Inserts
- 5mm Centre Drill
- 2 Stub Drills (5mm & 10mm)

Denford Consumables

TOOLING, CONSUMABLES & CURRICULUM PACKAGES



CONSUMABLES PACKAGES

F1 Model Block Car Kit

N13226F1M01

Includes 4 x F1 Class Wheels, 1 x Sandpaper, 2 x Screw Eyes, 2 x F1 Axles, 4 x Axle Bushes, 1 x F1 Model Block



50 Student Lithophane Consumables Package

CPLITHO

Cast Acrylic Sheet: 3mm Sky Blue 100 x 100mm x 50
 Cast Acrylic Sheet: 3mm White 100 x 100mm x 50
 Double Sided Tape x 2
 1/8" ID Reducing Bush 10mm Shank
 Engraving Cutter 0.4mm (1/64") 1/8" Shank 45 Degree x 2
 MDF Billet 5" x 8" x 5/8" (cut to size) x 2



Router Curriculum Consumables Package

CPR01

10 Hour 50 Student

MDF Billet 5" x 8" x 5/8" x 150
 MDF Billet 4" x 4" x 5/8" x 150
 Green Golf Tee (Pack of 250)
 Red Golf Tee (Pack of 250)



Turning Curriculum Consumables Package

CPTURN01

10 Hour 50 Student

Aluminium Bar 20mm Dia x 55mm Non-Anodised
 (Pack of 50) x 3

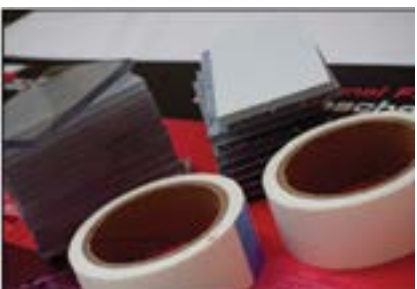

Milling Consumables Package

CPMILLO1

10 Hour 50 Student

Acrylic Billet 6" x 2.75" x 0.25" x 50
 Acrylic Billet 4" x 2.75" x 0.25" x 150
 Double Sided Tape x 2



Milling Consumables Package

30 Hour 50 Student

CPMILLO2

Protofoam Billet 3" x 2.75" x 0.75" x 150
 Protofoam Billet 1" x 1" x 1" x 50
 Double Sided Tape x 3



Milling Consumables Package

40 Hour 50 Student

CPMILLO3

Acrylic Billet 6" x 2.75" x 0.25" x 50
 Acrylic Billet 4" x 2.75" x 0.25" x 400
 Protofoam Billet 3" x 2.75" x 0.75" x 150
 Protofoam Billet 1" x 1" x 1" x 50
 Double Sided Tape x 5

CURRICULUM PACKAGES

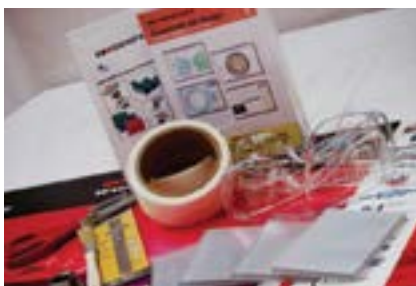

10 Hour Milling Curriculum and Consumables

Milling Curriculum CD (10 Hour)
 QuickCAM 2D Design (site licence)
 CNC Milling Basics Software
 Consumables Package 10 Hour Milling (50 Student)
 Engraving Cutter 0.4mm (1/64") 1/8" Shank 45 Degree
 Toolholder 1/8" Dia Bore
 Swarf Brush, Scissors, Safety Glasses x 2, 6" Steel Ruler

PKM10



30 Hour Milling Curriculum and Consumables

Milling Curriculum CD (30 Hour)
 CNC Milling Basics Software
 Consumables Package 30 Hour Milling (50 Student)
 Milling Vice
 Swarf Brush, Scissors, Safety Glasses x 2, 6" Steel Ruler
 3" Engineers Square, Ball Pein Hammer 1/4oz

PKM30



40 Hour Milling Curriculum and Consumables

Milling Curriculum CD (10 Hour)
 Milling Curriculum CD (30 Hour)
 CNC Milling Basics Software
 Consumables Package 10 Hour Milling (50 Student)
 Consumables Package 30 Hour Milling (50 Student)
 Milling Vice
 Swarf Brush, Scissors, Safety Glasses x 2, 6" Steel Ruler
 3" Engineers Square, Ball Pein Hammer 1/4oz

PKM40

Denford Consumables

TOOLING, CONSUMABLES & CURRICULUM PACKAGES



10 Hour Router Curriculum and Consumables

PKR10

Router Curriculum CD (10 Hour)
DXF Graphics CD (10 Hour Curriculum)
QuickCAM 2D Design (site licence)
Consumables Package 10 Hour Router (50 Students)
5/32" Dia. 1/4" Shank Router Plunge Bit
Safety Glasses x 2



10 Hour Turning Curriculum and Consumables

PKT10

Turning Curriculum CD (10 Hour)
QuickTURN 2D Design (site licence)
Consumables Package 10 Hour Turning (50 Students)
Swarf Brush
6" Steel Ruler
Safety Glasses x 2



MANUFACTURING PACKAGE

F1 in Schools Car Manufacturing Package

MPF101

F1 Model Block Car Kit x 25 Sets
F1 in Schools Car Manufacturing Fixture
Dust Pro 50 Extraction Unit **110v**
Virtual Wind Tunnel Software (single seat)
QuickCam Pro (site licence)
1/4" Dia Ball Nose L/S 2 Flute Cutter (Solid Carbide)
Paint Stand x 2, Safety Glasses x 2

DENFORD QUALITY STATEMENT:

Denford Limited has a proud history as a British based manufacturer and is steeped in the tradition of engineering and the manufacture of CNC machine tools.

With manufacturing facilities in the UK, Denford retains the best traditions of British machine tool design and has a well deserved reputation for quality and technological excellence; and with exports to over 80 countries, Denford products are used and acclaimed by leading education and training establishments throughout the world.

Denford Limited is ISO 9001 certified and our products comply with all European Health and Safety requirements and have CE Certification.

New product development continues as a key strategy for Denford Limited, whilst keeping their traditions of design and manufacture firmly based in Brighouse, West Yorkshire.

THE DENFORD MISSION STATEMENT:

“Denford are committed to providing quality, innovative and reliable technological solutions to support the education and training needs of current and future generations.”

Denford products span the complete learning spectrum: from easy-to-use CAD/CAM packages for teaching the principles of design and manufacture, through to CNC Milling Machines, Lathes and Routers, enabling the teaching of complex engineering concepts and manufacturing techniques. In addition, the company offers a range of 3D Printers and Laser Cutting / Engraving Machines, providing a variety of design & make options.

As Proud Founders and Sponsors of several unique educational projects including the “F1 in Schools STEM Challenge”, the “Land Rover 4x4 in Schools Challenge” and the “Jaguar Primary School Challenge”, Denford aims to provide ‘total packages’ to education, incorporating the highest level of technical assistance in terms of hardware, software, training and curriculum support materials.



On-Line Technical Forum

TECHNICAL SUPPORT AVAILABLE 24 HOURS A DAY, 7 DAYS A WEEK

Denford's Technical Forum is a free of charge on-line technical support service that is available to Denford customers 24 hours a day, 7 days a week.

“The technical forum has provided a wealth of information and support for our 20-year-old Denford CNC machine, in fact just as good as the support we receive for our brand new CNC Router!”



Denford's On-Line Technical Forum is a free of charge service that can be accessed 24 hours a day, 7 days a week.

The On-Line Technical Forum is available to Denford customers, old and new, and it couldn't be easier to use. Just visit <http://www.denfordata.com/bb/> and register on line.....it's that simple.

Denford's On-Line Technical Forum opens up the traditional communication channels that can restrict customer and technical support, due to availability of staff, teaching commitments or different time zones.

A multitude of topics relating to Denford machines and software (both new and old) are covered within the forum, which is simple to search, and easy to use.

Denford's Technical Team and Denford customers from around the world regularly log on to the forum to offer support and advice and, most importantly, post a solution for all to see.

As well as offering comprehensive technical support, Denford's On-Line Technical Forum enables customers to share ideas and projects with other users. Media such as teaching material, project work, PDF's, images, drawings and text documents are easily attached to messages for all users to view and comment on.

You can also read the latest Denford news before anyone else, and keep track of machine and software upgrades, some of which can be downloaded direct from the Technical Forum web site.

The On-Line Technical Forum has proved to be hugely popular with customers. One recent user posted a note to inform us that the Technical Forum has "provided a wealth of information and support for our 20-year-old Denford CNC machine, in fact just as good as the support we receive for our brand new CNC Router!"

Of course the traditional methods of phone and email are still available, but try out this new service by simply logging on to www.denfordata.com/bb/ and register.

